



Pedestal line

LISTINO | PRICE LIST

2026

ELEVATE YOUR POINT OF VIEW

MADE IN ITALY



Prodotto da materie plastiche industriali controllate, riciclate e nuovamente riciclabili.

Prenditi cura dell'ambiente: inserisci nel contenitore della plastica eventuale materiale in esubero, non abbandonarlo nell'ambiente, riciclare è importante per tutti.

Made with controlled, recycled and recyclable industrial plastics. Take care of the environment: put any surplus material in the plastic container, do not abandon it in the environment, recycling is important for everyone.

Altezze e caratteristiche Heights and Features	PG. 02
Consumo Consumption	PG. 04
PrimeUp	
Tile, Rail & Decking	PG. 06
Lunar Support	
Tile/Rail	PG. 08
Decking	PG. 10
MiniPro & BalancePro	
MiniPro	PG. 12
BalancePro Tile	PG. 14
BalancePro Hexagonal	PG. 16
BalancePro Rail	PG. 18
BalancePro Decking	PG. 20
Balance, Martinetto & Antishock	
Componi il tuo supporto Compose your support	PG. 22
MiniMart & MegaMart S	
Componi il tuo supporto Compose your support	PG. 24
GravitySystem	PG. 26
Rail System	PG. 28
Supporti fissi Fixed supports	PG. 29
DeckoLight	PG. 30
Deckofix & DSG	PG. 31
Skipper & LevelOut	PG. 32
Altri accessori Other accessories	PG. 33
MegaPro 4.0 & Sync	PG. 34
BalancePro V0	
Tile	PG. 38
Exagonal	PG. 39
Rail	PG. 40
Decking	PG. 41
SteelMart	
Tile & Decking	PG. 42
Condizioni di vendita Sale conditions	PG. 44



mm 10÷25

A

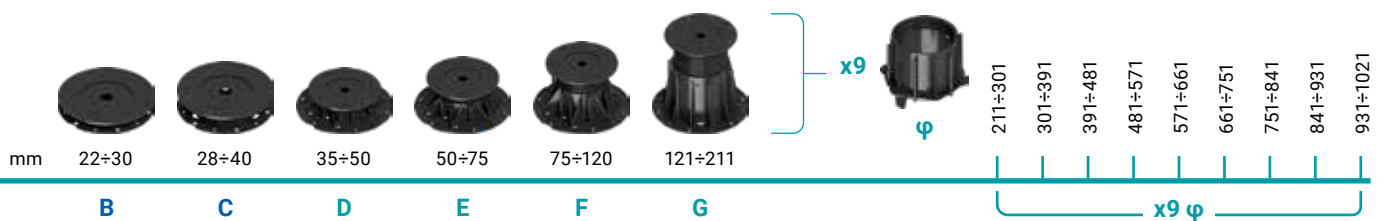
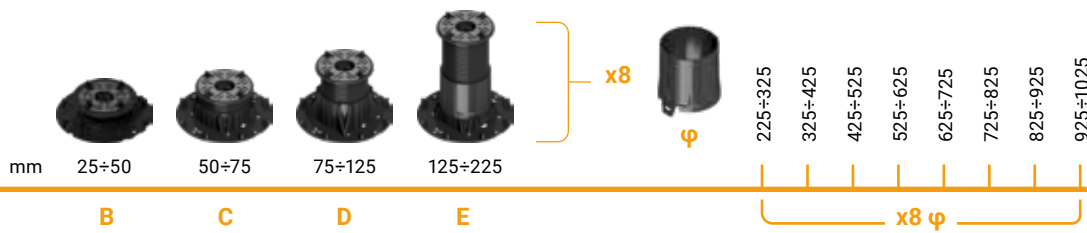
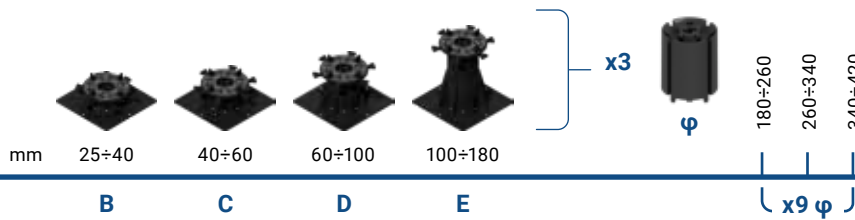

Caratteristiche

Features

	PrimeUp	Lunar Support	MiniPro	BalancePro	Martinetto	MiniMart	Megamart S	SteelMart	BalancePro V0
Regolazione con chiave Key adjustment	✗	✓	✓	✓	✗	✗	✗	✗	✓
Regolazione laterale Lateral adjustment	✓	✓	✓	✓	✓	✓	✓	✓	✓
Testa autolivellante Selflevelling Head	✗	✓	✓	✓	✗	✗	✗	✓	✓
Testa fissa Fixed head	✓	✓	✓	✓	✓	✓	✓	✓	✓
AntiShock	✗	✓	✓	✓	✗	✗	✗	✗	✓
Corpo unico Single part	✓	✓	✓	✓	✗	✓	✓	✓	✓
Rail System	✓	✓	✓	✓	✗	✓	✓	✓	✓
RumorStop Acoupad	✓	✓	✓	✓	✓	✓	✓	✗	✓
WallClip	✓	✓	✓	✓	✓	✓	✓	✓	✓
Clip alzata Rise clip	✗	✓	✓	✓	✓	✓	✓	✓	✓
Ignifugo Fire resistant	✗	✗	✗	✗	✗	✗	✗	✓	✓
Correttore di pendenza Slope corrector	✗	✓	✓	✓	✓	✗	✓	✗	✓

Video | Videos



Esplora la nostra raccolta di video per conoscere di più sul mondo Impertek: **novità di prodotto, tutorial per un corretto assemblaggio e guide pratiche all'installazione** ti accompagneranno in ogni fase del progetto.

Explore our video collection to learn more about the world of Impertek: **product updates, assembly tutorials and practical installation guides** to support you through every stage of your project.

Consumo | Consumption

COME CONTEGGIARE IL CONSUMO? | HOW TO CALCULATE CONSUMPTION?

TILE

Questo è un conteggio indicativo e non comprende il consumo relativo al perimetro. Per il calcolo preciso del consumo perimetrale bisogna procedere con la messa in pianta delle piastrelle e conteggiarle manualmente. In alternativa potete far eseguire il conteggio al nostro Software di calcolo on line MegaPro 4.0. Nel disegno seguente si può facilmente capire come il consumo perimetrale per metro quadro sia differente se prendiamo in esame un mq su un angolo (A) dove il consumo è di 6,5 pz (massima incidenza), oppure lungo il perimetro (B) dove il consumo scende a 5 pezzi (incidenza media) o nel caso di un mq all'interno dell'area (C) dove il consumo scende a 4 pz e corrisponde ad un pezzo per piastrella come risulta dalla nostra formula.

Suggeriamo di non superare mai l'interasse di 60 cm senza supporto.

We recommend never exceeding a 60 cm framework without a support.

Esempio: $1:0,50:0,50= 4,00$ pezzi per mq (che equivale ad 1 pezzo per piastrella)

Example: $1:0.50:0.50= 4.00$ pieces per sqm (which is equal to 1 piece per tile)

I = lato della piastrella | side of the tile

TILE

This is a rough count and does not include consumption related to the perimeter. To calculate the perimeter consumption accurately, one needs to layout the tiles and count them manually. Alternatively, use our online software MegaPro 4.0 to calculate the count. In the drawing below, you can easily understand how the perimeter consumption per square metre is different if we consider a square metre in a corner (A) where consumption is 6.5 pcs (maximum incidence) or along the perimeter (B) where consumption drops to 5 pcs (average incidence) or in the case of a square metre inside the area (C), where consumption drops to 4 pcs and equals one piece per tile, as shown in our formula.



Tabelle Calcolo Consumi: le Tabelle indicate contengono un puro calcolo matematico, sono escluse eventuali variabili di cantiere pertanto i valori di consumo sono indicativi e vi invitiamo ad aumentare i valori sopraindicati del 10 % circa. Consigliamo di rivolgersi sempre ai nostri tecnici specializzati per dettagli inerenti al conteggio dei supporti.

Consumption Calculation Tables: the Tables indicated contain a pure mathematical calculation, any site variables are excluded, therefore the consumption values are indicative and we invite you to increase the values indicated above by approximately 10 %. We recommend that you always contact our specialised technicians for details regarding the counting of the supports.

DECKING

Per il conteggio indicativo con la posa del decking è sufficiente conoscere l'interasse che intercorre tra i magatelli (travetti di legno, alluminio, WPC della sottostruttura) e dell'interasse tra un supporto e l'altro (vedi disegno): quindi se i vostri interassi sono entrambi di 40 cm trovate il consumo indicativo all'incrocio della colonna dei 40 cm e la riga dei 40 cm. Solitamente i due interassi sono uguali e per questo motivo nella tabellina troverete solo le dimensioni che disegnano un ipotetico quadrato. Anche con il decking il conteggio è puramente indicativo e fornisce un'idea di massima del numero di supporti per metro quadro necessari, ma non calcola il consumo di supporti lungo tutto il perimetro. Per il calcolo preciso del consumo perimetrale bisogna procedere con la messa in pianta del pavimento e conteggiare manualmente il consumo di supporti lungo il bordo (solitamente viene posato un magatello lungo tutto il perimetro). In alternativa potete far eseguire il conteggio al nostro Software di calcolo online MegaPro 4.0.

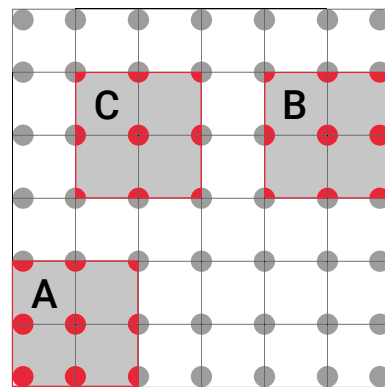
DECKING

For the approximate calculation with the laying of the decking it is sufficient to know the framework between the joists (wooden joists, aluminium, WPC of the substructure) and the framework between supports (see drawing): if your frameworks are both 40 cm, you can find the approximate consumption at the intersection of the 40 cm column with the 40 cm row. The two frameworks are usually identical and this is why the table only reports the sizes forming a hypothetical square. Also with decking, the count is only approximate and gives a rough idea of the necessary number of supports per square metre, but it does not calculate the consumption of supports along the whole perimeter. For an accurate calculation of the perimeter consumption, plan the floor and manually count the consumption of supports along the edge (a joist is laid along the whole perimeter). Alternatively, use our online software MegaPro 4.0 to calculate the count.

POSA CON PAVIMENTI TILE
INSTALLATION WITH TILE FLOORS

TILE

20 x 120 cm | 8,30 pz/m²

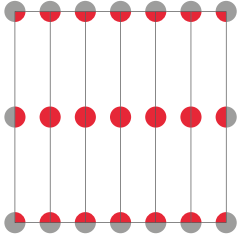

30 x 120 cm | 5,50 pz/m²

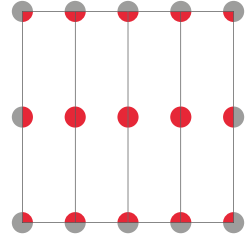

40 x 120 cm | 4,20 pz/m²

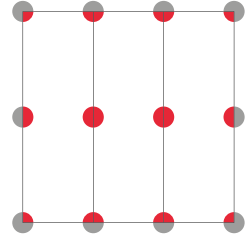

60 x 120 cm | 2,80 pz/m²

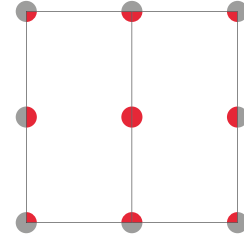

45 x 90 cm | 4,90 pz/m²

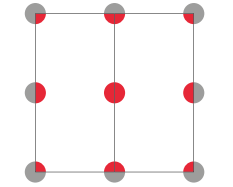

90 x 90 cm | 4,90 pz/m²

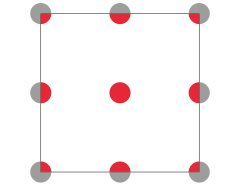

60 x 90 cm | 3,70 pz/m²

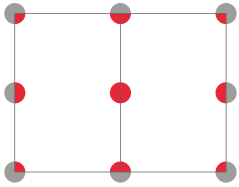

40 x 80 cm | 6,20 pz/m²

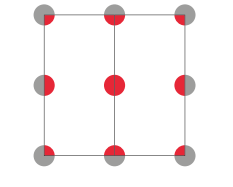

80 x 80 cm | 6,20 pz/m²

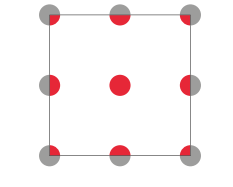

40 x 40 cm | 6,20 pz/m²

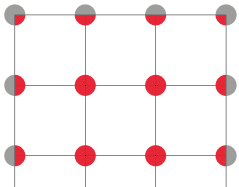

50 x 50 cm | 4,00 pz/m²

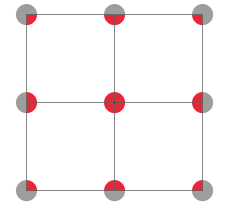

30 x 60 cm | 5,50 pz/m²

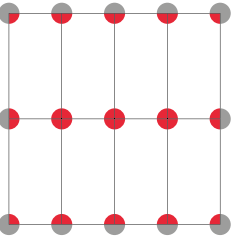

60 x 60 cm | 2,80 pz/m²

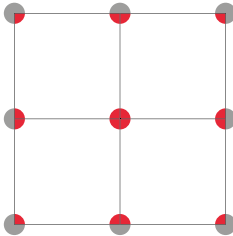

1 : L1 : L2
(1 : L1 : L2) : 2

IN PIÙ | PLUS

Evidenziamo che i conteggi sono
indicativi e non tengono conto del
perimetro o forme irregolari.

We highlight that the counts are
indicative and do not consider account
perimeter or irregular shapes.

		L 2			
		cm	40	50	60
L 1	20				8,30
	30				5,50
	40		6,20		4,20
	50			4,00	
	60				2,80

		L 2			
		cm	80	90	120
L 1	20				8,30
	30				5,50
	40		6,20	5,50	4,20
	60			3,70	2,80
	80		6,20		
	90			4,90	1,80

DECKING

POSA CON PAVIMENTI DECKING
INSTALLATION WITH DECKING FLOORS

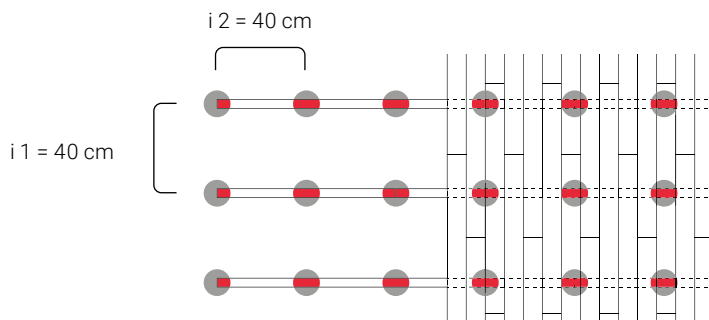

1 : i1 : i2

		i 2				
		cm	35	40	45	50
i 1	35		8,20			
	40			6,20		
	45				5,0	
	50					4,0

PrimeUp

Per altre altezze e spessori alette vedi pag. 24
For other tabs heights and thicknesses see page 24

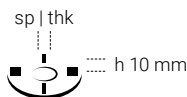
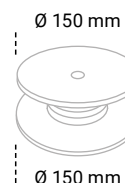

sp | thk 2 mm sp | thk 4 mm

PRIMEUP TILE

Prolunga h 5 mm
inclusa nel prezzo
Extension h 5 mm
included in the price



IMG.	H.min-max	ID	CODICE CODE	ID	CODICE CODE	€ cad	CONF each	CONF PACK	PLT
A	10-15 mm	PU201	240K621-001-010	PU401	240K626-001-010	1,55	20	1500	
A	10-20 mm	PU202	240K621-001-015	PU402	240K626-001-015	2,29	20	/	
	10-25 mm	PU203	240K621-001-020	PU403	240K626-001-020	3,03	20	/	

N.B: Testina, corpo e prolunghe in confezioni separate | Headpiece, body and extensions in separate packages

PLT H120

PRIMEUP RAIL



d 60 mm



d 40 mm

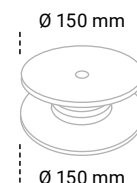

Prolunga h 5 mm
inclusa nel prezzo
Extension h 5 mm
included in the price

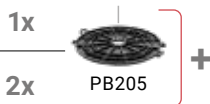

IMG.	H.min-max	ID	CODICE CODE	ID	CODICE CODE	€ cad	CONF each	CONF PACK	PLT
A	10-15 mm	PUR61	240K660-001-010	PUR41	240K665-001-010	1,55	20	1500	
A	10-20 mm	PUR62	240K660-001-015	PUR42	240K665-001-015	2,29	20	/	
	10-25 mm	PUR63	240K660-001-020	PUR43	240K665-001-020	3,03	20	/	

N.B: Testina, corpo e prolunghe in confezioni separate | Headpiece, body and extensions in separate packages

PLT H120

PRIMEUP DECKING



d 60 mm



d 70 mm

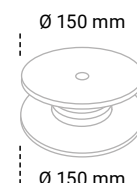

Prolunga h 5 mm
inclusa nel prezzo
Extension h 5 mm
included in the price



IMG.	H.min-max	ID	CODICE CODE	ID	CODICE CODE	€ cad	CONF each	CONF PACK	PLT
A	10-15 mm	PUL01	240K650-001-010	PUD01	240K655-001-010	1,60	20	1500	
A	10-20 mm	PUL02	240K650-001-015	PUD02	240K655-001-015	2,34	20	/	
	10-25 mm	PUL03	240K650-001-020	PUD03	240K655-001-020	3,08	20	/	

N.B: Testina, corpo e prolunghe in confezioni separate | Headpiece, body and extensions in separate packages

PLT H120

ACCESSORI EXTRA | EXTRA ACCESSORIES

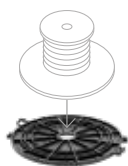

Prolunga h 5 mm
Extension h 5 mm

ID	CODICE CODE	€ cad each	CONF PACK	PLT
PB205	240-500-405-001	0,740	20	4900

PLT H120



WallClip

ID	CODICE CODE	€ cad each	CONF PACK
CLP01	240-935-100-001	1,00	50
CL-01	240-930-100-001	3,60	50

*Livellatore in gomma h 2,5 mm
Rubber Leveller h 2,5 mm



ID	CODICE CODE	€ cad each	CONF PACK
LG-25	240-910-150-003	0,388	100

*Consigliato 10% per ogni ordine
10% recommended for each order

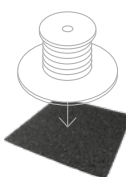

RumorStop h 5 mm
Acoupad h 5 mm

ID	CODICE CODE	€ cad each	CONF PACK
RS-05	240-230-100-005	2,50	50

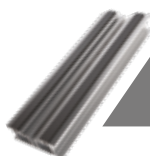

Magatello T-RAIL
T-RAIL joist

PG
28

Testa Top Rail
Top Rail Head



Utilizzabili solo
con Easy Rail
Usable only with
Easy Rail

ID	CODICE CODE	sp thk (mm)	€ cad each	CONF PACK
TR200	240-276-010-002	2	1,04	25
TR400	240-276-010-004	4	1,04	25

Magatello alluminio **Easy Rail** 60x20x2 mm (barre da 2ml)
Aluminum joist Easy Rail 60x20x2 mm (2ml bars)



ID	CODICE CODE	€/ml	CONF PACK
MAR60	420-705-020-060	16,00	10 ML

Magatello alluminio **Mini Rail** 40x20x2 mm (barre da 2ml)
Aluminum joist Mini Rail 40x20x2 mm (2ml bars)



ID	CODICE CODE	€/ml	CONF PACK
MAR40	420-705-020-040	12,00	10 ML

Innesto per magatello 20x60x2 mm
Joist fit 20x60x2 mm



ID	CODICE CODE	€ cad each	CONF PACK
IM-60	240-300-075-003	0,577	100

Innesto per magatello 20x40x2 mm
Joist fit 20x40x2 mm



ID	CODICE CODE	€ cad each	CONF PACK
IM-40	240-300-075-001	0,555	100

Clip per doppia orditura per Easy Rail
Clip for double understructure for Easy Rail



ID	CODICE CODE	€ cad each	CONF PACK
CDO60	240-300-100-060	0,514	20

Clip per doppia orditura per Easy Rail
Clip for double understructure for Easy Rail



ID	CODICE CODE	€ cad each	CONF PACK
CDO40	240-300-100-040	0,407	20

Lunar Support TILE / RAIL



FISSO | FIX

Regolabile dall'alto attraverso chiave*
Adjustable from the top thanks to PocketKey*

Regolazione laterale
Lateral adjustment

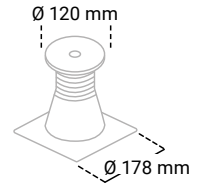

Larghezza testa 120 mm
Head width 120 mm

Base quadrata
Square base



Da 25 a 420 mm con 4 referenze
From 25 to 420 with 4 articles

* sp. 2 mm senza regolazione dall'alto
* sp. 4 mm con regolazione dall'alto
* thk. 2 mm without adjustment from the top
* thk. 4 mm with adjustment from the top

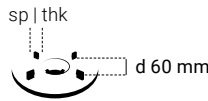

sp | thk 2 mm

sp | thk 4 mm

IMG.	H.min-max	sp thk 2 mm		sp thk 4 mm		€ cad each	CONF PACK	PLT
		ID	CODICE CODE	ID	CODICE CODE			
B	25-40 mm	SL200	240-410-180-025	SL400	240-420-180-025	3,80	20	560
C	40-60 mm	SL201	240-410-180-040	SL401	240-420-180-040	4,10	20	480
D	60-100 mm	SL202	240-410-180-060	SL402	240-420-180-060	4,75	20	320
E	100-180 mm	SL203	240-410-180-100	SL403	240-420-180-100	5,50	20	240

PLT H120

TILE



POCKET KEY PK-BP
cod. 240-940-050-004
17,53 €/each

1 pz/pcs per conf/pack

Non inclusa nella scatola
Not included in the box

UNICA TESTA | ONE HEAD
DOPPIA FUNZIONALITÀ | DOUBLE FUNCTION



RAIL / DECKING

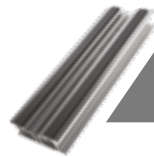

Magatello T-RAIL
T-RAIL joist

PG
28

Utilizzabile anche con Easy Rail vedi pag 13
Also usable with Easy Rail on page 13

Grazie al sistema brevettato QuickOn, la gamma Lunar Support è compatibile, con un'unica testa, a molteplici finiture: dalle piastre in ceramica alle lastre in pietra, fino a listoni in decking posati su magatelli Impertek.

Thanks to the QuickOn patented system, the range of Lunar Support is compatible with a single head to several floor finishes: from ceramic tiles to stone slabs and decking laid on Impertek joists.

ACCESSORI EXTRA | EXTRA ACCESSORIES

Prolunga PLS80 h 80 mm
PLS80 extension h 80 mm



ID	CODICE CODE	€ cad each	CONF PACK	PLT
PSL80**	240-400-180-080	1,50	20	1200

** Max 3 prolunghe sovrapponibili.
Compatibili con i supporti Lunar a partire da 40 mm di altezza.
PLT H120
Max 3 extensions.
Compatible with Lunar supports starting from 40 mm height.

Prolunga PLS20 h 20 mm
PLS20 extension h 20 mm



ID	CODICE CODE	€ cad each	CONF PACK	PLT
PSL20**	240-400-180-020	0,70	40	3000

** Max 3 prolunghe sovrapponibili.
Compatibili con i supporti Lunar a partire da 40 mm di altezza.
PLT H120
Max 3 extensions.
Compatible with Lunar supports starting from 40 mm height.

Correttori di pendenza Lunar 1, 2, 3%
Lunar Slope Corrector 1, 2, 3%



ID	CODICE CODE	€ cad each	CONF PACK
CP1SL	240-400-701-001	0,77	100
CP2SL	240-400-701-002	0,77	100
CP3SL	240-400-701-003	0,77	100

Anello bascula AB-SL
AB-SL balance ring



ID	CODICE CODE	€ cad each	CONF PACK
AB-SL	240-400-180-001	0,50	100

WallClip



ID	CODICE CODE	€ cad each	CONF PACK
CLP01	240-935-100-001	1,00	50
CL-01	240-930-100-001	3,60	50

Kit SideClip Perimetro
Perimeter SideClip Kit



ID	CODICE CODE	€ cad each	CONF PACK
CSL05*	240-930-180-005	8,40	30

*Clip utilizzabili solo con ceramica sp 20 mm
Clips usable only with 20 mm thick ceramic

RumorStop h 5 mm
Acoupad h 5 mm

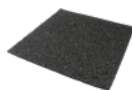

ID	CODICE CODE	€ cad each	CONF PACK
RS-05	240-230-100-005	2,50	50

BORDER SHIELD



Border Shield è l'accessorio Impertek progettato per mettere in sicurezza il perimetro delle pavimentazioni sopraelevate di terrazze e bordi piscina, evitando lo spostamento o il ribaltamento delle piastrelle. Facile da installare, compatibile con i supporti Pedestal Line e ispezionabile anche dopo la posa, Border Shield assicura una finitura stabile, sicura e curata in ogni dettaglio.

Border Shield is the Impertek accessory designed to secure the perimeter of raised floorings on terraces and pool edges, preventing tile shifting or tipping. Easy to install, compatible with Pedestal Line supports and inspectable even after installation, Border Shield ensures a stable, safe and refined finish in every detail.

ID	CODICE CODE	€ cad each	CONF PACK
BS-00	240-990-100-001	7,90	20

EDGEPLATE

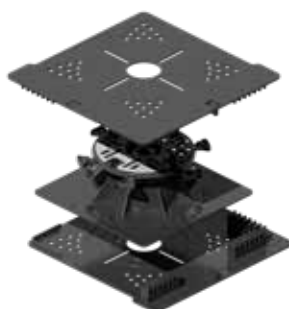

EdgePlate semplifica e perfeziona l'incollaggio delle piastrelle lungo il perimetro delle alzate e dei gradini. Composto da due piastre, da posizionare sulla testa e alla base del supporto, è dotato di fori e pettini che guidano la colla, assicurando un incollaggio sicuro delle piastrelle perimetrali, per una posa pulita, resistente e tecnicamente impeccabile.

EdgePlate simplifies and refines tile bonding along riser and step edges. Made of two plates placed at the top and base of the support, it features holes and combs that guide the adhesive, ensuring a secure and lasting bond of perimeter tiles for a clean, durable and technically flawless installation.

ID	CODICE CODE	€ cad each	CONF PACK
EP-00	240-935-200-005	3,10*	40

* Prezzo per pezzo (non per coppia). | Price per piece (not per pair).

Lunar Support DECKING

FISSO | FIX

Regolazione laterale
Lateral adjustment

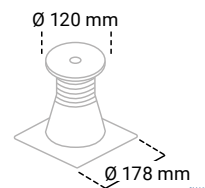

Larghezza testa 120 mm
Head width 120 mm

Base quadrata
Square base

Da 25 a 420 mm con 4 referenze
From 25 to 420 with 4 articles



d 40-80 mm

IMG.	H.min-max	ID	CODICE CODE	€ cad each	CONF PACK	PLT
B	25-40 mm	SLD00	240-470-180-025	4,10	20	560
C	40-60 mm	SLD01	240-470-180-040	4,40	20	480
D	60-100 mm	SLD02	240-470-180-060	5,05	20	320
E	100-180 mm	SLD03	240-470-180-100	5,80	20	240

PLT H120



ACCESSORI EXTRA | EXTRA ACCESSORIES

Prolunga PLS80 h 80 mm
PLS80 extension h 80 mm



ID	CODICE CODE	€ cad each	CONF PACK	PLT
PLS80**	240-400-180-080	1,50	20	1200

** Max 3 prolunghe sovrapponibili.
Compatibili con i supporti Lunar a partire da 40 mm di altezza.
Max 3 extensions.
Compatible with Lunar supports starting from 40 mm height.

PLT H120

RumorStop h 5 mm
Acoupad h 5 mm

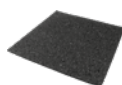

ID	CODICE CODE	€ cad each	CONF PACK
RS-05	240-230-100-005	2,50	50

Prolunga PLS20 h 20 mm
PLS20 extension h 20 mm



ID	CODICE CODE	€ cad each	CONF PACK	PLT
PSL20**	240-400-180-020	0,70	40	3000

** Max 3 prolunghe sovrapponibili.
Compatibili con i supporti Lunar a partire da 40 mm di altezza.
Max 3 extensions.
Compatible with Lunar supports starting from 40 mm height.

PLT H120

Anello bascula AB-SL
AB-SL balance ring



ID	CODICE CODE	€ cad each	CONF PACK
AB-SL	240-400-180-001	0,50	100

ACCESSORI EXTRA RAIL SYSTEM RAIL SYSTEM EXTRA ACCESSORIES

Magatello alluminio Easy Rail 60x20x2 mm (barre da 2ml)
Aluminum joist Easy Rail 60x20x2 mm (2ml bars)



ID	CODICE CODE	€/ml	CONF PACK
MAR60	420-705-020-060	16,00	10 ML

Magatello alluminio Mini Rail 40x20x2 mm (barre da 2ml)
Aluminum joist Mini Rail 40x20x2 mm (2ml bars)



ID	CODICE CODE	€/ml	CONF PACK
MAR40	420-705-020-040	12,00	10 ML

Innesto per magatello 20x60x2 mm
Joist fit 20x60x2 mm



ID	CODICE CODE	€ cad each	CONF PACK
IM-60	240-300-075-003	0,577	100

Innesto per magatello 20x40x2 mm
Joist fit 20x40x2 mm



ID	CODICE CODE	€ cad each	CONF PACK
IM-40	240-300-075-001	0,555	100

Clip per doppia orditura per Easy Rail
Clip for double understructure for Easy Rail



ID	CODICE CODE	€ cad each	CONF PACK
CDO60	240-300-100-060	0,514	20

Clip per doppia orditura per Easy Rail
Clip for double understructure for Easy Rail



ID	CODICE CODE	€ cad each	CONF PACK
CDO40	240-300-100-040	0,407	20

MiniPro TILE / RAIL

AUTOLIVELLANTE | SELF-LEVELLING

Regolabile dall'alto attraverso chiave*
Adjustable from the top thanks to PocketKey*

Regolazione laterale
Lateral adjustment

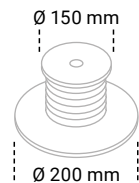

Prolunga MiniDome compresa nella confezione



MiniDome extension included in the box

Larghezza testa di 150 mm
Head width 150 mm

Da 25 a 50 mm con un unico prodotto
From 25 to 50 with a single product

* sp. 2 mm senza regolazione dall'alto
* sp. 4 mm con regolazione dall'alto
* thk. 2 mm without adjustment from the top
* thk. 4 mm with adjustment from the top

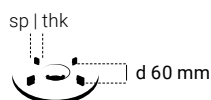

IMG.	H.min-max	sp thk 2 mm		sp thk 4 mm		€ cad each	CONF PACK	PLT
		ID	CODICE CODE	ID	CODICE CODE			
/	25-50 mm *	MP201	240-810-001-025	MP401	240-820-001-025	4,60	20	480

* 25 - 37,5 mm -> 37,5 - 50 mm compreso kit | kit included

PLT H120

PROLUNGA | EXTENSION

DOME applicabile tra la testa e la vite
DOME applicable between head and screw

Prolunga DOME h 25 mm
DOME extension h 25 mm

ID	CODICE CODE	€ cad each	CONF PACK	PLT
DE-25	240-700-610-025	0,75	40	1800



DOME

Altezza finita
Total height

50-75 mm

Prodotto venduto separatamente | Product sold separately

PLT H120

Sovrapponibile (massimo 3 x DE-25) | Stackable (max 3 x DE-25)

TILE



UNICA TESTA | ONE HEAD
DOPPIA FUNZIONALITÀ | DOUBLE FUNCTION



RAIL / DECKING



POCKET KEY PK-BP
cod. 240-940-050-004
17,53 €/each
1 pz/pcs per conf/pack
Non inclusa nella scatola
Not included in the box



BLOCCO BASCULA
FIX RING
BB-BP
20 pz/pcs per conf/pack
Incluso nella scatola
Included in the box

ACCESSORI EXTRA | EXTRA ACCESSORIES

Testa Top Rail
Top Rail Head



Utilizzabili solo con Easy Rail
Usable only with Easy Rail

ID	CODICE CODE	sp thk (mm)	€ cad each	CONF PACK
TR200	240-276-010-002	2	1,04	25
TR400	240-276-010-004	4	1,04	25

WallClip



ID	CODICE CODE	€ cad each	CONF PACK
CLP01	240-935-100-001	1,00	50
CL-01	240-930-100-001	3,60	50

Magatello alluminio Easy Rail 60x20x2 mm (barre da 2m)
Aluminum joist Easy Rail 60x20x2 mm (2ml bars)



ID	CODICE CODE	€/ml	CONF PACK
MAR60	420-705-020-060	16,00	10 ML

Kit SideClip Perimetro
Perimeter SideClip Kit



ID	CODICE CODE	€ cad each	CONF PACK
CL-06	240-930-100-005	16,83	30

Clip utilizzabili solo con ceramica sp 20 mm
Clips usable only with 20 mm thick ceramic

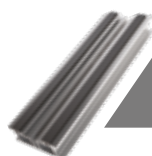

Magatello T-RAIL
T-RAIL joist

PG
28

Kit SideClip Angolare
Corner SideClip Kit



ID	CODICE CODE	€ cad each	CONF PACK
CL-07	240-930-110-005	37,60	4

Clip utilizzabili solo con ceramica sp 20 mm
Clips usable only with 20 mm thick ceramic

Innesto per magatello 20x60x2 mm
Joist fit 20x60x2 mm



ID	CODICE CODE	€ cad each	CONF PACK
IM-60	240-300-075-003	0,577	100

Clip per doppia orditura per Easy Rail
Clip for double understructure for Easy Rail



ID	CODICE CODE	€ cad each	CONF PACK
CDO60	240-300-100-060	0,514	20

BORDER SHIELD



Border Shield è l'accessorio Impertek progettato per mettere in sicurezza il perimetro delle pavimentazioni sopraelevate di terrazze e bordi piscina, evitando lo spostamento o il ribaltamento delle piastrelle. Facile da installare, compatibile con i supporti Pedestal Line e ispezionabile anche dopo la posa, Border Shield assicura una finitura stabile, sicura e curata in ogni dettaglio.

Border Shield is the Impertek accessory designed to secure the perimeter of raised floorings on terraces and pool edges, preventing tile shifting or tipping. Easy to install, compatible with Pedestal Line supports and inspectable even after installation, Border Shield ensures a stable, safe and refined finish in every detail.

ID	CODICE CODE	€ cad each	CONF PACK
BS-00	240-990-100-001	7,90	20

BalancePro TILE

AUTOLIVELLANTE | SELF-LEVELLING

Regolabile dall'alto attraverso chiave*
Adjustable from the top thanks to PocketKey*

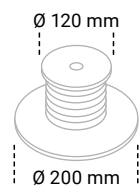

Per altezze fino a 25 mm vedi pag. 6
For heights up to 25 mm see page 6

* sp. 2 mm senza regolazione dall'alto
* sp. 4 mm con regolazione dall'alto
* thk. 2 mm without adjustment from the top
* thk. 4 mm with adjustment from the top

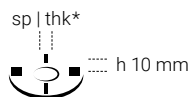

sp | thk 2 mm sp | thk 4 mm

IMG.	H.min-max	ID	CODICE CODE	ID	CODICE CODE	€ cad each	CONF PACK	PLT
B	25-30 mm	BP201*	240-710-001-025	BP401	240-720-001-025	4,28	20	480
C	30-37 mm	BP202*	240-710-001-030	BP402	240-720-001-030	4,53	20	480
D	37-50 mm	BP203*	240-710-001-037	BP403	240-720-001-037	4,87	20	320
E	50-75 mm	BP204*	240-710-001-050	BP404	240-720-001-050	5,73	20	320
F	75-125 mm	BP205*	240-710-001-075	BP405	240-720-001-075	6,48	20	240
G	125-225 mm	BP206*	240-710-001-125	BP406	240-720-001-125	8,90	20	240
	225-325 mm	BP207*	240K710-001-225	BP407	240K720-001-225	11,38	20	/
	325-425 mm	BP208*	240K710-001-325	BP408	240K720-001-325	13,86	20	/
	425-525 mm	BP209*	240K710-001-425	BP409	240K720-001-425	16,34	20	/
	525-625 mm	BP210*	240K710-001-525	BP410	240K720-001-525	18,82	20	/
	625-725 mm	BP211*	240K710-001-625	BP411	240K720-001-625	21,30	20	/
	725-825 mm	BP212*	240K710-001-725	BP412	240K720-001-725	23,78	20	/
	825-925 mm	BP213*	240K710-001-825	BP413	240K720-001-825	26,26	20	/
	925-1025 mm	BP214*	240K710-001-925	BP414	240K720-001-925	28,74	20	/

1x

2x

3x

4x

5x

6x

7x

8x



PBP10

Prolunga h 100 mm
inclusa nel prezzo
Extension h 100 mm
included in the price

G

* Materiali disponibili solo su ordinazione con tempistiche da concordare. Il prezzo fa riferimento al supporto completo di testa. | Materials available only on order with timing to be agreed. Price refers to both body and head.

PLT H120



POCKET KEY PK-BP
cod. 240-940-050-004
17,53 €/each
1 pz/pcs per conf/pack

Non inclusa nella scatola
Not included in the box



BLOCCO BASCULA
FIX RING
BB-BP

20 pz/pcs per conf/pack

Incluso nella scatola
Included in the box



BLOCCO ROTAZIONE
TWIST LOCK RING
BR-BP

20 pz/pcs per conf/pack

Incluso nella scatola
Included in the box

ACCESSORI EXTRA | EXTRA ACCESSORIES



ID	CODICE CODE	€ cad each	CONF PACK	PLT
DE-25	240-700-610-025	0,75	40	1800

Sovrapponibile (massimo 3 x DE-25) | Stackable (max 3 x DE-25) PLT H120

DOMO DE-25

Dome è la prolunga progettata con sistema ad incastro sopra la vite centrale del supporto che lo estende di 25 mm.

DOMO DE-25

Dome is the extension designed with an interlocking system over the central screw of the support that extends it to 25 mm.

Prolunghe EX-05 (5 mm) e EX-10 (10 mm) Extensions EX-05 (5 mm) and EX-10 (10 mm)



ID	CODICE CODE	€ cad each	CONF PACK
EX-05	240-700-610-005	1,26	20
EX-10	240-700-610-010	1,54	20



WallClip

ID	CODICE CODE	€ cad each	CONF PACK
CLP01	240-935-100-001	1,00	50
CL-01	240-930-100-001	3,60	50

Prolunga PBP10 (h 100 mm) Extension PBP10 (h 100 mm)



ID	CODICE CODE	€ cad each	CONF PACK	PLT
PBP10	240-700-603-006	2,48	20	360

PLT H120



Kit SideClip Perimetro Perimeter SideClip Kit

ID	CODICE CODE	€ cad each	CONF PACK
CL-06	240-930-100-005	16,83	30

Clip utilizzabili solo con ceramica sp 20 mm
Clips usable only with 20 mm thick ceramic

RumorStop h 5 mm Acoupad h 5 mm

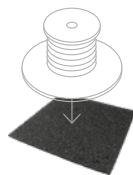

ID	CODICE CODE	€ cad each	CONF PACK
RS-05	240-230-100-005	2,50	50



Kit SideClip Angolare Corner SideClip Kit

ID	CODICE CODE	€ cad each	CONF PACK
CL-07	240-930-110-005	37,60	4

Clip utilizzabili solo con ceramica sp 20 mm
Clips usable only with 20 mm thick ceramic

BORDER SHIELD



Border Shield è l'accessorio Impertek progettato per mettere in sicurezza il perimetro delle pavimentazioni sopraelevate di terrazze e bordi piscina, evitando lo spostamento o il ribaltamento delle piastrelle. Facile da installare, compatibile con i supporti Pedestal Line e ispezionabile anche dopo la posa, Border Shield assicura una finitura stabile, sicura e curata in ogni dettaglio.

Border Shield is the Impertek accessory designed to secure the perimeter of raised floorings on terraces and pool edges, preventing tile shifting or tipping. Easy to install, compatible with Pedestal Line supports and inspectable even after installation, Border Shield ensures a stable, safe and refined finish in every detail.

ID	CODICE CODE	€ cad each	CONF PACK
BS-00	240-990-100-001	7,90	20

EDGEPLATE



EdgePlate semplifica e perfeziona l'incollaggio delle piastrelle lungo il perimetro delle alzate e dei gradini. Composto da due piastre, da posizionare sulla testa e alla base del supporto, è dotato di fori e pettini che guidano la colla, assicurando un incollaggio sicuro delle piastrelle perimetrali, per una posa pulita, resistente e tecnicamente impeccabile.

EdgePlate simplifies and refines tile bonding along riser and step edges. Made of two plates placed at the top and base of the support, it features holes and combs that guide the adhesive, ensuring a secure and lasting bond of perimeter tiles for a clean, durable and technically flawless installation.

ID	CODICE CODE	€ cad each	CONF PACK
EP-00	240-935-200-005	3,10	40

* Prezzo per pezzo (non per coppia). | Price per piece (not per pair).

BalancePro HEXAGONAL TILE

AUTOLIVELLANTE | SELF-LEVELLING

Per piastre esagonali - Regolabile dall'alto attraverso chiave*
For hexagonal tiles - Adjustable from the top thanks to PocketKey*

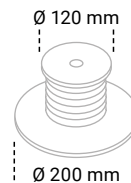

sp. 2-3 mm senza regolazione dall'alto
sp. 4 mm con regolazione dall'alto
thk. 2 mm without adjustment from the top
thk. 4 mm with adjustment from the top
disponibile anche con spessori 2 e 3 mm
available also with thicknesses 2-3 mm

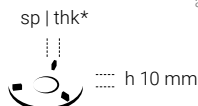

sp | thk 4 mm

IMG.	H.min-max	ID	CODICE CODE	€ cad each	CONF PACK	PLT
B	25-30 mm	BPY41	240-775-004-025	4,29	20	480
C	30-37 mm	BPY42	240-775-004-030	4,54	20	4801
D	37-50 mm	BPY43	240-775-004-037	4,89	20	320
E	50-75 mm	BPY44	240-775-004-050	5,75	20	320
F	75-125 mm	BPY45	240-775-004-075	6,51	20	240
G	125-225 mm	BPY46	240-775-004-125	8,93	20	240
	225-325 mm	BPY47	240K775-004-225	11,41	20	/
	325-425 mm	BPY48	240K775-004-325	13,89	20	/
	425-525 mm	BPY49	240K775-004-425	16,37	20	/
	525-625 mm	BPY50	240K775-004-525	18,85	20	/
	625-725 mm	BPY51	240K775-004-625	21,33	20	/
	725-825 mm	BPY52	240K775-004-725	23,81	20	/
	825-925 mm	BPY53	240K775-004-825	26,29	20	/
	925-1025 mm	BPY54	240K775-004-925	28,77	20	/

- 1x
- 2x
- 3x
- 4x
- 5x
- 6x
- 7x
- 8x



PBP10

Prolunga h 100 mm inclusa nel prezzo
Extension h 100 mm included in the price



POCKET KEY PK-BP
cod. 240-940-050-004
17,53 €/each
1 pz/pcs per conf/pack

Non inclusa nella scatola
Not included in the box



BLOCCO BASCULA
FIX RING
BB-BP

20 pz/pcs per conf/pack

Incluso nella scatola
Included in the box



BLOCCO ROTAZIONE
TWIST LOCK RING
BR-BP

20 pz/pcs per conf/pack

Incluso nella scatola
Included in the box

Materiali disponibili solo su ordinazione con tempistiche da concordare. Il prezzo fa riferimento al supporto completo di testa. | Materials available only on order with timing to be agreed. Price refers to both body and head.

PLT H120

ACCESSORI EXTRA | EXTRA ACCESSORIES



ID	CODICE CODE	€ cad each	CONF PACK	PLT
DE-25	240-700-610-025	0,75	40	1800

Sovrapponibile (massimo 3 x DE-25) | Stackable (max 3 x DE-25) PLT H120

DOME DE-25

Dome è la prolunga progettata con sistema ad incastro sopra la vite centrale del supporto che lo estende di 25 mm.

DOME DE-25

Dome is the extension designed with an interlocking system over the central screw of the support that extends it to 25 mm.

Prolunghe EX-05 (5 mm) e EX-10 (10 mm)
Extensions EX-05 (5 mm) and EX-10 (10 mm)



ID	CODICE CODE	€ cad each	CONF PACK
EX-05	240-700-610-005	1,26	20
EX-10	240-700-610-010	1,54	20

WallClip



ID	CODICE CODE	€ cad each	CONF PACK
CLP01	240-935-100-001	1,00	50
CL-01	240-930-100-001	3,60	50

Prolunga PBP10 (h 100 mm)
Extension PBP10 (h 100 mm)



ID	CODICE CODE	€ cad each	CONF PACK	PLT
PBP10	240-700-603-006	2,48	20	360

PLT H120

Kit SideClip Perimetro
Perimeter SideClip Kit



ID	CODICE CODE	€ cad each	CONF PACK
CL-06	240-930-100-005	16,83	30

Clip utilizzabili solo con ceramica sp 20 mm
Clips usable only with 20 mm thick ceramic

RumorStop h 5 mm
Acoupad h 5 mm

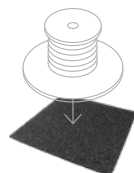

ID	CODICE CODE	€ cad each	CONF PACK
RS-05	240-230-100-005	2,50	50

Kit SideClip Angolare
Corner SideClip Kit

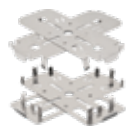

ID	CODICE CODE	€ cad each	CONF PACK
CL-07	240-930-110-005	37,60	4

Clip utilizzabili solo con ceramica sp 20 mm
Clips usable only with 20 mm thick ceramic

BalancePro RAIL

AUTOLIVELLANTE | SELF-LEVELLING

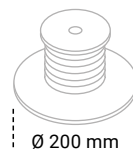

Per altezze fino a 25 mm vedi pag. 6
For heights up to 25 mm see page 6



d 60 mm



d 40 mm

IMG.	H.min-max	ID	CODICE CODE	€ cad each	ID	CODICE CODE	€ cad each	CONF PACK	PLT
B	25-30 mm	BPH01	240-735-001-025	5,12	BPJ01	240-730-001-025	4,68	20	480
C	30-37 mm	BPH02	240-735-001-030	5,37	BPJ02	240-730-001-030	4,93	20	480
D	37-50 mm	BPH03	240-735-001-037	5,60	BPJ03	240-730-001-037	5,13	20	320
E	50-75 mm	BPH04	240-735-001-050	6,45	BPJ04	240-730-001-050	5,98	20	320
F	75-125 mm	BPH05	240-735-001-075	7,21	BPJ05	240-730-001-075	6,74	20	240
G	125-225 mm	BPH06	240-735-001-125	9,59	BPJ06	240-730-001-125	9,15	20	240
	225-325 mm	BPH07	240K735-001-225	12,07	BPJ07	240K730-001-225	11,63	20	/
	325-425 mm	BPH08	240K735-001-325	14,55	BPJ08	240K730-001-325	14,11	20	/
	425-525 mm	BPH09	240K735-001-425	17,03	BPJ09	240K730-001-425	16,59	20	/
	525-625 mm	BPH10	240K735-001-525	19,51	BPJ10	240K730-001-525	19,07	20	/
	625-725 mm	BPH11	240K735-001-625	21,99	BPJ11	240K730-001-625	21,55	20	/
	725-825 mm	BPH12	240K735-001-725	24,47	BPJ12	240K730-001-725	24,03	20	/
	825-925 mm	BPH13	240K735-001-825	26,95	BPJ13	240K730-001-825	26,51	20	/
	925-1025 mm	BPH14	240K735-001-925	29,43	BPJ14	240K730-001-925	28,99	20	/

1x

2x

3x

4x

5x

6x

7x

8x



PBP10

Prolunga h 100 mm
inclusa nel prezzo
Extension h 100 mm
included in the price

+ **G**

Materiali disponibili solo su ordinazione con tempistiche da concordare. Il prezzo fa riferimento al supporto completo di testa. | Materials available only on order with timing to be agreed. Price refers to both body and head.

PLT H120

BALANCEPRO KIT



TESTA AUTOLIVELLANTE
Con correzione automatica della pendenza fino al 5%

SELF-LEVELLING HEAD
with automatic slope correction up to 5%



TESTA FISSA
Con utilizzo dell'anello FIX RING

FIXED HEAD
with FIX RING



BLOCCO BASCULA
FIX RING
BB-BP

20 pz/pcs per conf/pack

Incluso nella scatola
Included in the box

ACCESSORI EXTRA | EXTRA ACCESSORIES

Testa Top Rail
Top Rail Head



Utilizzabili solo con Easy Rail
Usable only with Easy Rail

ID	CODICE CODE	sp thk (mm)	€ cad each	CONF PACK
TR200	240-276-010-002	2	1,04	25
TR400	240-276-010-004	4	1,04	25



ID	CODICE CODE	€ cad each	CONF PACK	PLT
DE-25	240-700-610-025	0,75	40	1800

Sovrapponibile (massimo 3 x DE-25) | Stackable (max 3 x DE-25) PLT H120

DOME DE-25

Dome è la prolunga progettata con sistema ad incastro sopra la vite centrale del supporto che lo estende di 25 mm.

DOME DE-25

Dome is the extension designed with an interlocking system over the central screw of the support that extends it to 25 mm.

Prolunga PBP10 (h 100 mm)
Extension PBP10 (h 100 mm)



ID	CODICE CODE	€ cad each	CONF PACK	PLT
PBP10	240-700-603-006	2,48	20	360

PLT H120

Prolunghe EX-05 (5 mm) e EX-10 (10 mm)
Extensions EX-05 (5 mm) and EX-10 (10 mm)



ID	CODICE CODE	€ cad each	CONF PACK
EX-05	240-700-610-005	1,26	20
EX-10	240-700-610-010	1,54	20

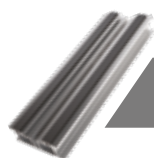

Magatello T-RAIL
T-RAIL joist

PG 28

Magatello alluminio Easy Rail 60x20x2 mm (barre da 2ml)
Aluminum joist Easy Rail 60x20x2 mm (2ml bars)



ID	CODICE CODE	€/ml	CONF PACK
MAR60	420-705-020-060	16,00	10 ML

Magatello alluminio Mini Rail 40x20x2 mm (barre da 2ml)
Aluminum joist Mini Rail 40x20x2 mm (2ml bars)



ID	CODICE CODE	€/ml	CONF PACK
MAR40	420-705-020-040	12,00	10 ML



Innesto per magatello 20x60x2 mm
Joist fit 20x60x2 mm

ID	CODICE CODE	€ cad each	CONF PACK
IM-60	240-300-075-003	0,577	100



Innesto per magatello 20x40x2 mm
Joist fit 20x40x2 mm

ID	CODICE CODE	€ cad each	CONF PACK
IM-40	240-300-075-001	0,555	100



Clip per doppia orditura per Easy Rail
Clip for double understructure for Easy Rail

ID	CODICE CODE	€ cad each	CONF PACK
CDO60	240-300-100-060	0,514	20

BalancePro DECKING

AUTOLIVELLANTE | SELF-LEVELLING

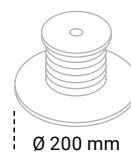

Per altezze fino a 25 mm vedi pag. 6
For heights up to 25 mm see page 6



d 40-60 mm

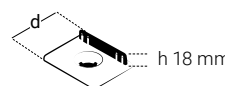

d max 70 mm

IMG.	H.min-max	ID	CODICE CODE	€ cad each	ID	CODICE CODE	€ cad each	CONF PACK	PLT
B	25-30 mm	BPX01	240-770-001-025	4,28	BPD01	240-750-001-025	4,31	20	480
C	30-37 mm	BPX02	240-770-001-030	4,53	BPD02	240-750-001-030	4,56	20	480
D	37-50 mm	BPX03	240-770-001-037	4,87	BPD03	240-750-001-037	4,90	20	320
E	50-75 mm	BPX04	240-770-001-050	5,72	BPD04	240-750-001-050	5,75	20	320
F	75-125 mm	BPX05	240-770-001-075	6,48	BPD05	240-750-001-075	6,51	20	240
G	125-225 mm	BPX06	240-770-001-125	8,91	BPD06	240-750-001-125	8,93	20	240
	225-325 mm	BPX07	240K770-001-225	11,39	BPD07	240K750-001-225	11,41	20	/
	325-425 mm	BPX08	240K770-001-325	13,87	BPD08	240K750-001-325	13,89	20	/
	425-525 mm	BPX09	240K770-001-425	16,35	BPD09	240K750-001-425	16,37	20	/
	525-625 mm	BPX10	240K770-001-525	18,83	BPD10	240K750-001-525	18,85	20	/
	625-725 mm	BPX11	240K770-001-625	21,31	BPD11	240K750-001-625	21,33	20	/
	725-825 mm	BPX12	240K770-001-725	23,79	BPD12	240K750-001-725	23,81	20	/
	825-925 mm	BPX13	240K770-001-825	26,27	BPD13	240K750-001-825	26,29	20	/
	925-1025 mm	BPX14	240K770-001-925	28,75	BPD14	240K750-001-925	28,77	20	/

1x

2x

3x

4x

5x

6x

7x

8x



PBP10

Prolunga h 100 mm
inclusa nel prezzo
Extension h 100 mm
included in the price

+ **G**

BLOCCO BASCULA
FIX RING
BB-BP

20 pz/pcs per conf/pack

Incluso nella scatola
Included in the box

BALANCEPRO KIT



TESTA AUTOLIVELLANTE
Con correzione automatica della pendenza fino al 5%

SELF-LEVELLING HEAD
with automatic slope correction up to 5%



TESTA FISSA
Con utilizzo dell'anello FIX RING

FIXED HEAD
with FIX RING

PLT H120

ACCESSORI EXTRA | EXTRA ACCESSORIES



ID	CODICE CODE	€ cad each	CONF PACK	PLT
DE-25	240-700-610-025	0,75	40	1800

Sovrapponibile (massimo 3 x DE-25) | Stackable (max 3 x DE-25) PLT H120

DOME DE-25

Dome è la prolunga progettata con sistema ad incastro sopra la vite centrale del supporto che lo estende di 25 mm.

DOME DE-25

Dome is the extension designed with an interlocking system over the central screw of the support that extends it to 25 mm.

Prolunga PBP10 (h 100 mm)
Extension PBP10 (h 100 mm)



ID	CODICE CODE	€ cad each	CONF PACK	PLT
PBP10	240-700-603-006	2,48	20	360

PLT H120

Prolunghe EX-05 (5 mm) e EX-10 (10 mm)
Extensions EX-05 (5 mm) and EX-10 (10 mm)



ID	CODICE CODE	€ cad each	CONF PACK
EX-05	240-700-610-005	1,26	20
EX-10	240-700-610-010	1,54	20

RumorStop h 5 mm
Acoupad h 5 mm

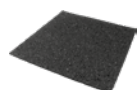

ID	CODICE CODE	€ cad each	CONF PACK
RS-05	240-230-100-005	2,50	50

Componi il tuo supporto

MODALITÀ DI CALCOLO PRICING CALCULATION

Per calcolare il prezzo del supporto completo si deve sommare il prezzo del corpo con quello della testa.

To calculate the price of the complete support, sum the price of the body and the one of the head.

Esempio | Example

Corpo | Body SM001 > 240-323-300-035 > **3,21€**
+
Testa | Head TB210 > 240-285-000-002 > **1,86€**
=
5,07€

Balance & Martinetto

	H.min-max	H.min-max	senza testa without head		€ cad each	CONF PACK
			ID	CODICE CODE		
B	47-62 mm	35-50 mm	SM001	240-323-300-035	3,21	25
C	62-82 mm	50-70 mm	SM002	240-323-300-050	3,38	25
D	77-112 mm	65-100 mm	SM003	240-323-300-065	3,41	25
E	107-142 mm	95-130 mm	SM004	240-323-300-095	3,55	25
F	97-147 mm	85-135 mm	SM013	240-323-301-085	4,58	25
G	137-227 mm	125-215 mm	SM014	240-323-301-125	5,08	25
H	222-392 mm	210-380 mm	SM015	240-323-301-210	7,24	25

* Disponibilità e tempistiche da concordare | Availability and timing to be agreed

Teste Balance h 10 mm Balance heads h 10 mm



TB210
cod. 240-285-000-002
1,860 €/each
25 pcs per conf/pack
Sp | thk 2 mm



TB410
cod. 240-285-000-004
1,860 €/each
25 pcs per conf/pack
Sp | thk 4 mm

Teste Paver h 18 mm Paver heads h 18 mm



TF218
cod. 240-300-010-120
0,680 €/each
25 pcs per conf/pack
Sp | thk 2 mm



TF418
cod. 240-300-016-120
0,680 €/each
25 pcs per conf/pack
Sp | thk 4 mm

Teste Antishock h 10 mm Antishock heads h 10 mm



TS210
cod. 240-277-010-002
1,000 €/each
25 pcs per conf/pack
Sp | thk 2 mm



TS410
cod. 240-277-010-004
1,000 €/each
25 pcs per conf/pack
Sp | thk 4 mm

Teste Decking Decking heads



TX-SM
cod. 240-300-022-120
0,690 €/each
25 pcs per conf/pack



TD-SM
cod. 240-300-021-080
0,870 €/each
25 pcs per conf/pack



T0-SM
cod. 240-300-000-120
0,690 €/each
25 pcs per conf/pack

Compose your support

** Applicabile tra la testa e la vite
** Applicable between head and screw

Prolunga Martinetto h 15 mm
Extension for Jack support h 15 mm

ID	CODICE CODE	€ cad each	CONF PACK
PM-15*	240-300-061-015	0,550	25

Solo per supporto 47-62 mm | Just for supports 47-62 mm



B

+

PM-15**



=

Altezza Finita
Total height

62-77 mm



Sovrapponibile | Stackable

Prolunga Martinetto h 20 mm
Extension for Jack support h 20 mm

ID	CODICE CODE	€ cad each	CONF PACK
PM-20*	240-300-061-020	0,635	25

Solo per supporto 62-82 mm | Just for supports 62-82 mm

C

+

PM-20



=

82-102 mm



Non sovrapponibile | Non-stackable

Prolunga Martinetto h 30 mm
Extension for Jack support h 30 mm

ID	CODICE CODE	€ cad each	CONF PACK
PM-30*	240-300-061-030	0,753	25

Solo per supporti 77-112 / 107-142 mm | Just for supports 77-112 / 107-142 mm

* Su richiesta | On request

D/E

+

PM-30



=

107-142 mm
137-172 mm



Sovrapponibile (massimo due pezzi) | Stackable (max 2 pcs)

ACCESSORI EXTRA | EXTRA ACCESSORIES

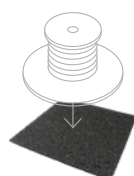

RumorStop h 5 mm
Acoupad h 5 mm

ID	CODICE CODE	€ cad each	CONF PACK
RS-05	240-230-100-005	2,50	50



WallClip

ID	CODICE CODE	€ cad each	CONF PACK
CLP01	240-935-100-001	1,00	50
CL-01	240-930-100-001	3,60	50

*Livellatore in gomma h 2,5 mm
Rubber Leveller h 2,5 mm



ID	CODICE CODE	€ cad each	CONF PACK
LG-25	240-910-150-003	0,388	100



Kit SideClip Perimetro
Perimeter SideClip Kit

ID	CODICE CODE	€ cad each	CONF PACK
CL-06	240-930-100-005	16,83	30

*Consigliato 10% per ogni ordine
10% recommended for each order

Correttore di pendenza 1, 2, 3%
Slope Corrector 1, 2, 3%



ID	CODICE CODE	€ cad each	CONF PACK
CP-01	240-500-701-001	1,48	20
CP-02	240-500-701-002	1,48	20
CP-03	240-500-701-003	1,48	20



Kit SideClip Angolare
Corner SideClip Kit

ID	CODICE CODE	€ cad each	CONF PACK
CL-07	240-930-110-005	37,60	4

Clip utilizzabili solo con ceramica sp 20 mm
Clips usable only with 20 mm thick ceramic

Componi il tuo supporto

MODALITÀ DI CALCOLO PRICING CALCULATION

* Disponibilità e tempistiche da concordare | Availability and timing to be agreed

Per calcolare il prezzo del supporto completo si deve sommare il prezzo del corpo con quello della testina.

To calculate the price of the complete support, sum the price of the body and the one of the headpiece.

Esempio | Example

Corpo | Body PU001 > 240-617-001-010 > **1,21€**
Testina | Headpiece TA216 > 240-500-016-002 > **0,340€**
 = **1,55€**

PrimeUp

	H.min-max	senza testina without headpiece		€ cad each	CONF PACK
		ID	CODICE CODE		
A	10-15 mm	PU001	240-617-001-010	1,21	20
A	10-20 mm	PU002	240K617-001-015	1,95	20
A	10-25 mm	PU003	240K617-001-020	2,69	20

MiniMart

B	22-30 mm	MN001	240-617-001-022	3,69	20
C	28-40 mm	MN002	240-617-001-028	3,86	20

MegaMart S

	H.min-max	senza testina without headpiece		€ cad each	CONF PACK
		ID	CODICE CODE		
D	35-50 mm	MM001	240-617-001-035	4,71	20
E	50-75 mm	MM002	240-617-001-050	6,03	20
F	75-120 mm	MM003	240-617-001-075	6,73	20
G	121-211 mm	MS001	240-617-002-121	8,14	20
	211-301 mm	MS002	240K617-002-211	10,81	20
	301-391 mm	MS003	240K617-002-301	13,48	20
	391-481 mm	MS004	240K617-002-391	16,15	20
	481-571 mm	MS005	240K617-002-481	18,82	20
	571-661 mm	MS006	240K617-002-571	21,49	20
	661-751 mm	MS007	240K617-002-661	24,16	20
	751-841 mm	MS008	240K617-002-751	26,83	20
	841-931 mm	MS009	240K617-002-841	29,50	20
	931-1021 mm	MS010	240K617-002-931	32,17	20

Testine tile h 16 mm Tile headpieces h 16 mm



Testine tile h 10 mm Tile headpieces h 10 mm

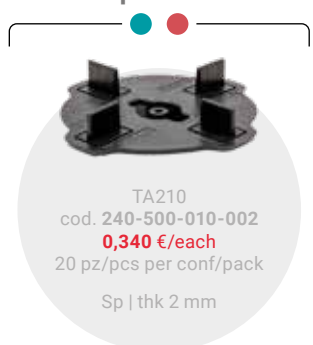

Testine Decking Decking headpieces



Testine Rail System Rail System headpieces

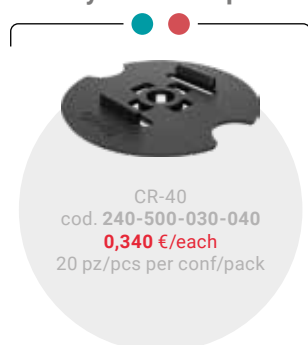

Compose your support

ACCESSORI EXTRA MEGAMART S MEGAMART S EXTRA ACCESSORIES

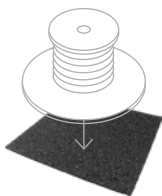

RumorStop h 5 mm
Acoupad h 5 mm

ID	CODICE CODE	€ cad each	CONF PACK
RS-05	240-230-100-005	2,50	50



Chiave di regolazione Easy Key
Regulation key EasyKey

ID	CODICE CODE	€ cad each	CONF PACK
EK-04	240-500-900-001	3,39	20



Correttore di pendenza 1, 2, 3%
Slope Corrector 1, 2, 3%

ID	CODICE CODE	€ cad each	CONF PACK
CP-01	240-500-701-001	1,48	20
CP-02	240-500-701-002	1,48	20
CP-03	240-500-701-003	1,48	20



WallClip

ID	CODICE CODE	€ cad each	CONF PACK
CLP01	240-935-100-001	1,00	50
CL-01	240-930-100-001	3,60	50



* Livellatore in gomma h 2,5 mm
Rubber Leveller h 2,5 mm

ID	CODICE CODE	€ cad each	CONF PACK
LG-25	240-910-150-003	0,388	100

* Consigliato 10% per ogni ordine
10% recommended for each order

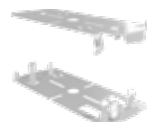

Kit SideClip Perimetro
Perimeter SideClip Kit

ID	CODICE CODE	€ cad each	CONF PACK
CL-06	240-930-100-005	16,83	30

Clip utilizzabili solo con ceramica sp 20 mm | Clips usable only with 20 mm thick ceramic



Prolunga h 90 mm
Extension h 90 mm

ID	CODICE CODE	€ cad each	CONF PACK
PMS09	240-500-450-001	2,67	20

Prolunga compatibile solo con MS001 | Extension compatible with MS001 only

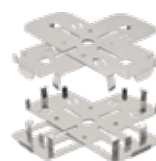

Kit SideClip Angolare
Corner SideClip Kit

ID	CODICE CODE	€ cad each	CONF PACK
CL-07	240-930-110-005	37,60	4

Clip utilizzabili solo con ceramica sp 20 mm | Clips usable only with 20 mm thick ceramic

GravitySystem



GRAVITYGRID

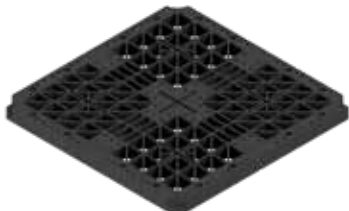

È il cuore del sistema: garantisce sicurezza e stabilità alla pavimentazione, anche in caso di rottura delle piastrelle.

It's the heart of the system: it guarantees safety and stability for flooring, even in the event of tile breakage.

ID	CODICE CODE	MISURA SIZE	€ cad each	PLT*
GS-GG	270-000-000-000	597x597 mm	30,50	120

*Non sovrapponibile / Not stackable

GRAVITYSPACER



Semplifica la posa di piastrelle, anche multiformato, garantendo un'installazione sicura ed esteticamente perfetta senza necessità di incollare la finitura.

It simplifies the installation of tiles, even multi-format, ensuring a safe and aesthetically perfect installation without the need to glue the finish.

ID	CODICE CODE	MISURA SIZE	€ cad each	CONF PACK
GS-S2	270-000-500-002	2 mm	1,05	100
GS-S4	270-000-500-004	4 mm	1,05	100

GRAVITYSNAP

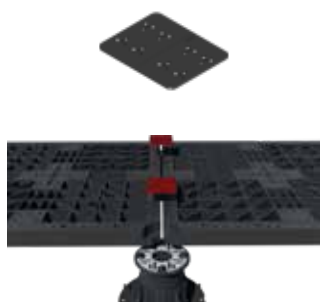

È l'accessorio progettato per collegare tra loro le griglie GravityGrid in tutte le situazioni in cui non è previsto l'incollaggio della piastrella, prevenendo eventuali spostamenti delle griglie.

It's the accessory designed to connect GravityGrids together in all situations where tile bonding is not required, preventing any movement of the grids.

ID	CODICE CODE	€ cad each	CONF PACK
GS-GS	270-000-200-005	0,75	100

Incompatibile con GravityCover, GravityFit e profilo metallico di rinforzo.
Incompatible with GravityCover, GravityFit and metal reinforcement profile.

GRAVITYFIT



Velocizza e semplifica l'installazione di GravityGrid direttamente sulla testa dei supporti, garantendo una posa precisa e mantenendo il sistema ispezionabile.

It speeds up and simplifies the installation of GravityGrid directly on the head of the supports, ensuring a precise installation while keeping the system inspectable.

ID	CODICE CODE	€ cad each	CONF PACK
GS-GF	270-000-200-001	0,75	60

Incompatibile con GravitySnap, GravityCover e profilo metallico di rinforzo.
Incompatible with GravitySnap, GravityCover and metal reinforcement profile.

GRAVITYCOVER



È progettato per la posa di manti di erba sintetica: garantisce una copertura perfetta di tutte le aperture per prevenire qualsiasi rischio di affondamento. Dotato di fori di drenaggio, consente il deflusso dell'acqua, garantendo l'integrità nel tempo del manto sintetico.

It's designed for the installation of synthetic grass surfaces: it ensures perfect coverage of every openings to prevent any risk of sinking. Equipped with drainage holes, it allows water to flow through, preserving the integrity of the synthetic surface over time.

ID	CODICE CODE	€ cad each	CONF PACK
GS-CV	270-000-500-100	3,90	60

Incompatibile con GravitySnap, GravityFit e profilo metallico di rinforzo con supporti sp. 4 mm (solo con aggancio tra GravityGrid tramite GravityCover). | Incompatible with GravitySnap, GravityFit, and the metal reinforcement profile with 4 mm thick supports (only when GravityGrid are connected via GravityCover).

PROFILO METALLICO DI RINFORZO | METAL REINFORCEMENT PROFILE



ID	CODICE CODE	€ cad each	CONF PACK
GS-GP	270-000-420-030	1,60*	40

* Prezzo non scontabile. | Non-discountable price.

Incompatibile con GravitySnap, GravityFit e GravityLock+GravityCross.
Incompatible with GravitySnap, GravityFit and GravityLock + GravityCross.

TOPKEY



I supporti rimangono sempre regolabili in altezza grazie alla chiave TopKey; anche a pavimentazione completata è infatti possibile correggere eventuali dislivelli, garantendo sempre la perfetta resa estetica.

Supports are always height-adjustable thanks to the TopKey; even after the flooring is installed, it is possible to correct any unevenness, ensuring a perfect aesthetic result.

ID	CODICE CODE	€ cad each	CONF PACK
TK-BP	240-940-050-010	39,50	1

Sistema antivento | Windproof system

GRAVITYLOCK



BalancePro / MiniPro

Lunar Support

GravityLock fissa la griglia al supporto, garantendo sicurezza, stabilità ottimale e manutenzione facilitata; GravityCross crea invece fughe estetiche e uniformi da 4 mm.

GravityLock secures the grid to the support, ensuring safety, optimal stability and easy maintenance; GravityCross, on the other hand, creates uniform and visually attractive 4 mm joints.

ID	CODICE CODE	€ cad each	CONF PACK
GS-LB	270-000-100-700	1,00	120
GS-LL	270-000-100-400	1,00	120

Incompatibile con profilo metallico di rinforzo. | Incompatible with metal reinforcement profile.

GRAVITYCROSS



ID	CODICE CODE	€ cad each	CONF PACK
GS-GC	270-000-100-004	0,50	120

Rail System

TILE & DECKING

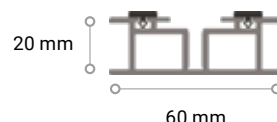

T-RAIL



T-Rail è un magatello in alluminio versatile per la posa di lastre in ceramica, pietra e doghe in legno. Con crocette per fughe precise e guarnizione TPE per l'assorbimento dei rumori.

T-Rail is a versatile aluminium joist for laying ceramic and stone slabs, and wooden slats. With crosses for precise joints and a TPE gasket for sound absorption.

ID	DESCRIZIONE DESCRIPTION	CODICE CODE	€	CONF PACK
MAT61	Magatello Joist T-Rail MAT61 60x20mm 2ml	420-715-020-060	20,00 €/ml	10 ml
MAT60	Magatello Joist T-Rail MAT60 60x20mm 2ml + asola slot	420-710-020-060*	26,00 €/ml	10 ml

* Articolo su ordinazione | Article on order



ID	DESCRIZIONE DESCRIPTION	CODICE CODE	€	CONF PACK
GAS02	Guarnizione AS in TPE per magatello T-Rail m50 TPE Antishock gasket for T-Rail Joist m50	240-911-000-010	1,40 €/ml	100 ml
TC-04	Distanziatore TC-04 a crocetta per magatello T-Rail TC-04 cross spacer for T-Rail Joist	240-030-010-004	0,250 €/pz	120
IM-TR	Innesto per magatello T-Rail Joist fit Rail IM-TR	240-300-075-004	0,577 €/pz	100

EASY RAIL

Magatello alluminio **Easy Rail** 60x20x2 mm (barre da 2ml)
Aluminum joist **Easy Rail** 60x20x2 mm (2ml bars)



ID	CODICE CODE	€/ml	CONF PACK
MAR60	420-705-020-060	16,00	10 ML

Innesto per magatello 20x60x2 mm
Joist fit 20x60x2 mm



ID	CODICE CODE	€ cad each	CONF PACK
IM-60	240-300-075-003	0,577	100

Testa Top Rail
Top Rail Head



ID	CODICE CODE	sp thk (mm)	€ cad each	CONF PACK
TR200	240-276-010-002	2	1,04	25
TR400	240-276-010-004	4	1,04	25

Clip per doppia orditura per Easy Rail
Clip for double understructure for Easy Rail



ID	CODICE CODE	€ cad each	CONF PACK
CDO60	240-300-100-060	0,514	20

MINI RAIL

Magatello alluminio **Mini Rail** 40x20x2 mm (barre da 2ml)
Aluminum joist **Mini Rail** 40x20x2 mm (2ml bars)



ID	CODICE CODE	€/ml	CONF PACK
MAR40	420-705-020-040	12,00	10 ML

Innesto per magatello 20x40x2 mm
Joist fit 20x40x2 mm



ID	CODICE CODE	€ cad each	CONF PACK
IM-40	240-300-075-001	0,555	100

Supporti fissi

TILE & DECKING

FIXED SUPPORTS

ELASTIC



EL-01



EL-02



EL-03



EL-04



EL-05



EL-06

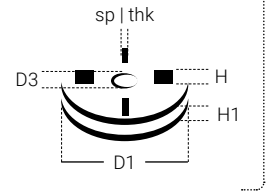

ID	CODICE CODE	H1	D3	D1	H	sp thk	€ cad each	CONF PACK
EL-01	240-211-150-003	3-8	/	150	/	/	2,25	125
EL-02	240-216-150-005	5	20,6	150	/	/	2,06	150
EL-03	240-216-150-007	7	19,4	150	/	/	2,00	125
EL-04	240K216-626-007	7	19,4	150	10	4	2,29	125
EL-05	240-216-050-005	5	2,6	50	/	/	0,424	300
EL-06	240K216-650-007	7	19,4	150	/	/	2,43	125

TILE

DECKING

FISSI

FIXED SUPPORTS



SF-14

ID	CODICE CODE	H1	H	sp thk	D1	D2	€ cad each	CONF PACK
SF-14	240-100-150-014	14	10	4	150	/	0,45	300
SF-17	240-100-150-017	17	10	4	150	/	0,48	250

FISSI ANTISHOCK

FIXED ANTISHOCK

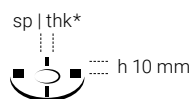

sp | thk 2 mm sp | thk 4 mm



SA402

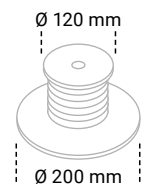

H.min-max	ID	CODICE CODE	ID	CODICE CODE	€ cad each	CONF PACK
25 mm	SA201*	240K377-100-025	SA401	240K378-100-025	2,85	25
35 mm	SA202*	240K377-100-035	SA402	240K378-100-035	2,95	25

DeckoLight TILE/RAIL & DECKING

AUTOLIVELLANTE | SELF-LEVELLING

Regolabile dall'alto attraverso PocketKey
Adjustable from the top thanks to PocketKey

Regolazione laterale
Lateral adjustment



Deckolight è il nuovo supporto Impertek in polipropilene ad alta resistenza, progettato per la posa diretta sul terreno senza necessità di basi o fondazioni. Ideale per pavimentazioni sopraelevate da esterno, assicura stabilità, precisione e sicurezza. Compatibile con teste Lunar Decking e Tile/Rail, consente la posa di ceramica, pietra e decking su un unico sistema, ideale per giardini e camminamenti outdoor.

Deckolight is Impertek's new high-strength polypropylene support, designed for direct installation on the ground without the need for bases or foundations. Ideal for elevated outdoor flooring, it ensures stability, precision, and safety. Compatible with Lunar Decking and Tile/Rail heads, it allows the installation of ceramic, stone, and decking on a single system, making it perfect for gardens and outdoor walkways.



	CODICE CODE	€ cad each	CONF PACK
DeckoLight Decking	240K915-100-470	68,00	20
DeckoLight Tile/Rail	240K915-100-420	68,00	20

ACCESSORI EXTRA | EXTRA ACCESSORIES



Adattatore di avvitamento DeckoLight
DeckoLight screwing adapter

CODICE CODE	€ cad each	CONF PACK
240-915-100-100	125,00	1



Prolunga PLS20 h 20 mm
PLS20 extension h 20 mm

ID	CODICE CODE	€ cad each	CONF PACK	PLT
PLS20**	240-400-180-020	0,70	40	3000

** Max 3 prolunghe sovrapponibili | Max 3 extensions.

PLT H120



Prolunga PLS80 h 80 mm
PLS80 extension h 80 mm

ID	CODICE CODE	€ cad each	CONF PACK	PLT
PLS80**	240-400-180-080	1,50	20	1200

** Max 3 prolunghe sovrapponibili | Max 3 extensions.

PLT H120



PocketKey
PocketKey

ID	CODICE CODE	€ cad each	CONF PACK
PK-BP	240-940-050-004	17,53	1



Anello bascula AB-SL
AB-SL balance ring

ID	CODICE CODE	€ cad each	CONF PACK
AB-SL	240-400-180-001	0,50	100

DeckoFix DECKING

FISSO | FIX



DF-01

PDF26

Deckofix è una soluzione innovativa ed ecologica per la creazione di passaggi pedonali, terrazzamenti e bordi piscina, apprezzata per la sua facilità di installazione e rimozione. Piantato direttamente nel terreno senza necessità di basi cementate, Deckofix riduce l'impatto ambientale e può essere riciclato una volta rimosso. Con un diametro di 123 mm, è compatibile con travetti da 120x200 mm e offre una portata di 800 kg per supporto. Resistente a temperature da -50°C a 90°C, è ideale per ambienti freddi e caldi. La regolazione in altezza da 35 a 250 mm consente un'installazione precisa e adattabile.

Deckofix is an innovative and environmentally friendly solution for the creation of walkways, terraces and pool sides, appreciated for its ease of installation and removal. Inserted directly into the ground without the need for concrete bases, Deckofix reduces the environmental impact and can be recycled once removed. With a diameter of 123 mm, it is compatible with 120x200 mm joists and offers a load capacity of 800 kg per support. Resistant to temperatures from -50°C to 90°C, it is ideal for cold and hot environments. The height adjustment from 35 to 250 mm allows for precise and adaptable installation.

ID	CODICE CODE	€ cad each	CONF PACK
DF-01	240-915-000-005	172,00	1
PDF26	240-915-000-010	34,00	1

DECKODRIVER & DECKOTOOL



ID	DESCRIZIONE DESCRIPTION	CODICE CODE	€ cad each	CONF PACK
DD-01	Avvitatore per Deckofix Battery Driver for Deckofix	240-915-000-015	*	1
DD-01	Posizionatore per Deckofix Positioner for Deckofix	240-915-000-020	*	1

* Possibilità di acquisto e noleggio. Prezzo su richiesta. | Possibility of purchase and rental. Price on request.
* Fino ad esaurimento scorte | While stocks last

DSG TILE

FISSO | FIX



DSG40



DSG41

Supporti DSG ideali per pavimentazioni su sabbia, ghiaia ed erba. Rialzano le piastrelle e creano fughe perfette, con alette da 4 mm e puntale per terreni morbidi.

DSG supports are ideal for flooring on sand, gravel and grass. They raise the tiles and create perfect joints, with 4 mm tabs and an anchoring spike for soft ground.

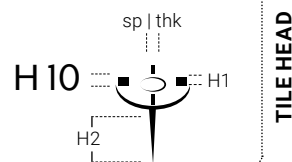

ID	CODICE CODE	sp thk	H1	H2	PCS	€ cad each	CONF PACK
DSG40	240-020-010-004	4	12,3	/	100	0,204	100
DSG41	240-020-020-004	4	12,3	45	100	0,232	100

Skipper TILE

ANTIVENTO | WINDPROOF

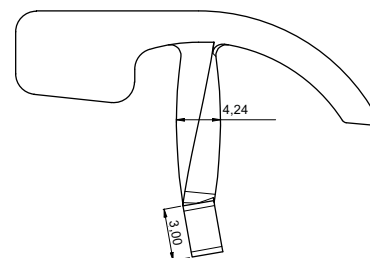
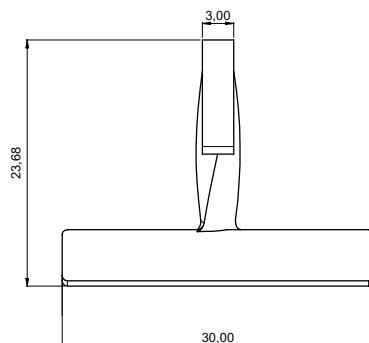
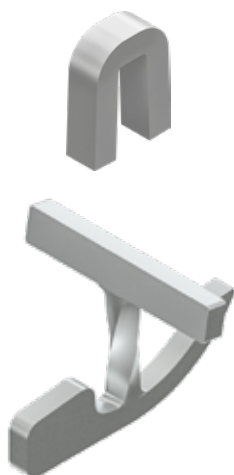

Skipper è l'antivento universale progettato per pavimentazioni sopraelevate da esterno. Resistente fino a 900 Pa/140 km/h, crea una connessione solida tra le piastre, prevenendo il sollevamento e riducendo i rischi di danni a persone e cose.

Skipper is the universal windproof system designed for outdoor raised flooring. It can withstand up to 900 Pa/140 km/h and creates a solid connection between the tiles, preventing them from lifting and reducing the risk of personal injury and property damage.

ID	CODICE CODE	sp thk	€ cad each	CONF PACK
SK-03	420-100-300-001	4*	3,60	250

* Fuga minima consentita tra piastrelle 4 mm | Minimum allowable joint between tiles 4 mm

LevelOut TILE

CUNEO | WEDGE



L01SP

L02SP



LO-WE



LO-SP



LOPPL



LOMPL

ID	DESCRIZIONE DESCRIPTION	CODICE CODE	€ Bag	CONF PACK
L01SP	Distanziatore 1 mm Levelling spacer 1 mm	240-025-010-001	21,95	200
L02SP	Distanziatore 2 mm Levelling spacer 2 mm	240-025-010-002	21,95	200
LO-WE	Cuneo nero Wedge black	240-025-015-000	15,43	100
LO-SP	Antiraffio piastrelle Scratch preventer	240-025-030-000	28,81	200
LOPPL	Pinza in plastica Plastic pliers	240-025-035-000	20,58	1
LOMPL	Pinza in metallo Metal pliers	240-025-040-000	38,58	1

Altri accessori

OTHER ACCESSORIES

MANIGLIE HANDLE



MR-01



MR-02



MR-03

ID	DESCRIZIONE DESCRIPTION	CODICE CODE	€ cad each	CONF PACK
MR-01	Maniglia regolabile 30-50 cm Adjustable handle 30-50 cm	240-920-030-050	52,36	1
MR-02	Maniglia regolabile 50-65 cm Adjustable handle 50-65 cm	240-920-030-065	178,18	1
MR-03*	Maniglia regolabile 50-120 cm Adjustable handle 50-120 cm	240-920-030-120	412,92	1

* Articolo su ordinazione | Article on order

MANIGLIA BIVENTOSA DOUBLE SUCTION CUP LIFTER



ID	DESCRIZIONE DESCRIPTION	CODICE CODE	€ cad each	CONF PACK
BV-01	Maniglia Biventosa Double suction cup lifter	240-920-040-001	97,47	1

La biventosa doppia, perfetta per la movimentazione e la posa delle piastrelle, è realizzata in alluminio pressofuso e grazie all'insero metallico saldato può reggere fino a 57 kg.

The double suction cup lifter, perfect for handling and laying tiles, is made of die-cast aluminum and can hold up to 57 kgs thanks to the welded metal insert.

ALZA PIASTRELLA TILE LIFTER



ID	DESCRIZIONE DESCRIPTION	CODICE CODE	€ cad each	CONF PACK
AP-02	Alza Piastrella Tile Lifter	240-920-050-002	15,00	1

L'alza piastrella permette di sollevare le piastrelle che sono già state posate in un pavimento. Inserendolo nella fuga, infatti, è possibile alzare le piastrelle adiacenti con una sola mano.

The tile lifter allows you to lift tiles that have already been laid in a floor. In fact, by inserting it into the joint, it is possible to raise the tiles with just one hand.

SPAZIATORI A CROCE CROSS-SPACERS



SPB03



SP-03

ID	DESCRIZIONE DESCRIPTION	CODICE CODE	€ cad each	CONF PACK
SPB03	Croce SP 3 h 10 Cross-spacer thk 3 h 10	240-005-010-003	0,086	2000
SPB04	Croce SP 4 h 10 Cross-spacer thk 4 h 10	240-005-010-004	0,089	2000
SPB05	Croce SP 5 h 10 Cross-spacer thk 5 h 10	240-005-010-005	0,096	2000
SP-03	Croce SP 3 h 19 Cross-spacer thk 3 h 19	240-010-020-003	0,130	1000
SP-04	Croce SP 4 h 19 Cross-spacer thk 4 h 19	240-010-020-004	0,143	1000
SP-05	Croce SP 5 h 19 Cross-spacer thk 5 h 19	240-010-020-005	0,189	1000

* Fino ad esaurimento scorte | While stocks last

MegaPro 4.0

WEB-APP PER LA PROGETTAZIONE DELLA POSA
WEB-APP FOR LAYING DESIGN



MegaPro 4.0 è la web-app di Impertek realizzata per progettare pavimenti sopraelevati da esterno con i supporti della gamma Pedestal Line di Impertek.

Accessibile online previa registrazione, offre strumenti avanzati per personalizzare disegni tecnici, scegliere i supporti più adatti, configurare finiture (decking, piastrelle, rail system) e generare distinte con i prodotti utilizzati.

Salva i tuoi progetti e lavora in modo professionale e intuitivo.

Scopri di più su megapro.impertek.it/it

MegaPro 4.0 is Impertek's web app designed for planning outdoor raised flooring using the supports from Impertek's Pedestal Line.

Accessible online after registration, it offers advanced tools to customize technical drawings, select the most suitable supports, configure finishes (decking, tiles, rail system), and generate bills of materials for the products used.

Save your projects and work professionally and intuitively.

Learn more at megapro.impertek.it/en

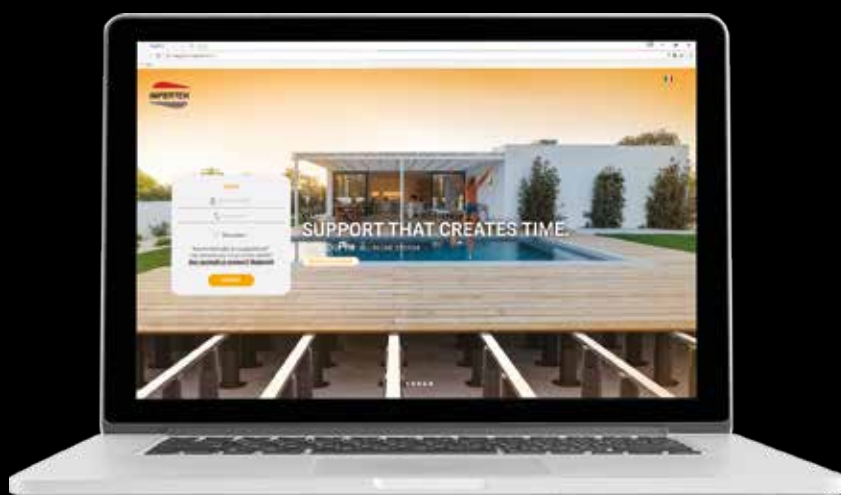

Inserisci la tua planimetria

Upload your plan

Specifica le altezze dell'area supporti e i dati del pavimento

Specify heights of supports area and flooring data

Esporta il PDF con la distinta dei supporti

Export the list of supports in PDF

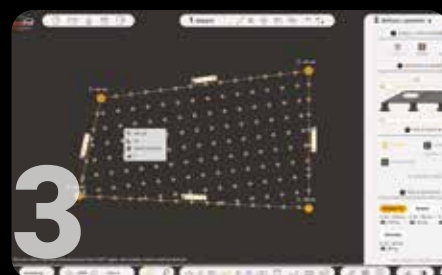
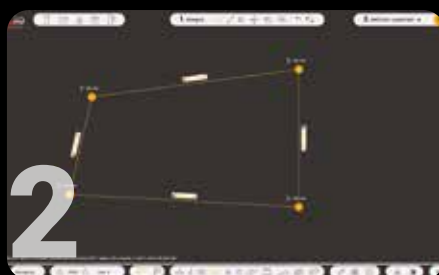



Sync

SYNC, IL PLUGIN PER AUTODESK REVIT DEDICATO AI PRODOTTI IMPERTEK

THE PLUGIN FOR AUTODESK REVIT DEDICATED TO IMPERTEK PRODUCTS

Sync per Autodesk Revit è il nuovo plugin di Impertek, pensato per studi tecnici, architetti e ingegneri, che consente la progettazione di pavimentazioni sopraelevate con supporti Impertek.

Integrato nel software CAD e BIM Revit, permette di calcolare altezze, esportare distinte in Excel e gestire più progetti simultaneamente. Facile da installare e aggiornare, è disponibile gratuitamente previa richiesta con licenza personale.

Sync migliora l'efficienza e l'integrazione nella progettazione, confermando l'impegno di Impertek per l'innovazione.

Sync for Autodesk Revit is the new plugin by Impertek, designed for technical studios, architects, and engineers, enabling the design of raised flooring with Impertek supports.

Fully integrated with Revit CAD and BIM software, it allows height calculations, Excel bill-of-material exports, and simultaneous management of multiple projects. Easy to install and update, it is available for free upon request with a personal license.

Sync enhances efficiency and integration in design, reaffirming Impertek's commitment to innovation.





PEDESTAL LINE
Fire Resistant



BalancePro V0 TILE

AUTOLIVELLANTE | SELF-LEVELLING

REGOLABILE DALL'ALTO ATTRAVERSO CHIAVE*
TOP ADJUSTMENT THANKS TO THE TOPKEY*

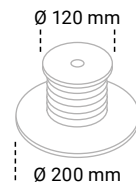

* sp. 2-3 mm senza regolazione dall'alto
* sp. 4-6 mm con regolazione dall'alto

* 2-3 mm thick without top adjustment
* 4-6 mm thick with top adjustment

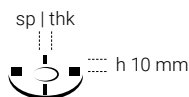

sp | thk 4 mm

IMG.	H.min-max	ID	CODICE CODE	€ cad each	CONF PACK
B	25-30 mm	FBP401	250-720-001-025	/	20
C	30-37 mm	FBP402	250-720-001-030	/	20
D	37-50 mm	FBP403	250-720-001-037	/	20
E	50-75 mm	FBP404	250-720-001-050	/	20
F	75-125 mm	FBP405	250-720-001-075	/	20
G	125-225 mm	FBP406	250-720-001-125	/	20
	225-325 mm	FBP407	250K720-001-225	/	20
	325-425 mm	FBP408	250K720-001-325	/	20
	425-525 mm	FBP409	250K720-001-425	/	20
	525-625 mm	FBP410	250K720-001-525	/	20
	625-725 mm	FBP411	250K720-001-625	/	20
	725-825 mm	FBP412	250K720-001-725	/	20
	825-925 mm	FBP413	250K720-001-825	/	20
	925-1025 mm	FBP414	250K720-001-925	/	20

1x

2x

3x

4x

5x

6x

7x

8x



FPBP10

Prolunga h 100 mm
inclusa nel prezzo
Extension h 100 mm
included in the price

Non inclusa nella scatola
Not included in the box



POCKET KEY PK-BP
cod. 240-940-050-004
17,53 €/each
1 pz/pcs per conf/pack

Non inclusa nella scatola
Not included in the box



BLOCCO BASCULA
FIX RING
BB-BP

20 pz/pcs per conf/pack

Incluso nella scatola
Included in the box



BLOCCO ROTAZIONE
TWIST LOCK RING
BR-BP

20 pz/pcs per conf/pack

Incluso nella scatola
Included in the box

BalancePro V0 TILE EXAGONAL

AUTOLIVELLANTE | SELF-LEVELLING

PER PIASTRE ESAGONALI REGOLABILE DALL'ALTO ATTRAVERSO CHIAVE*
FOR EXAGONAL TILES ADJUSTABLE FROM THE TOP THANKS TO TOPKEY*

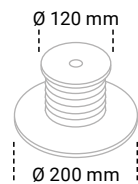

* sp. 2-3 mm senza regolazione dall'alto
* sp. 4 mm con regolazione dall'alto

* thk. 2-3 mm without adjustment from the top
* thk. 4 mm with adjustment from the top

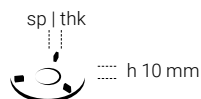

sp | thk 4 mm

IMG.	H.min-max	ID	CODICE CODE	€ cad each	CONF PACK
B	25-30mm	FBPY41	250-775-004-025	/	20
C	30-37 mm	FBPY42	250-775-004-030	/	20
D	37-50 mm	FBPY43	250-775-004-037	/	20
E	50-75 mm	FBPY44	250-775-004-050	/	20
F	75-125 mm	FBPY45	250-775-004-075	/	20
G	125-225 mm	FBPY46	250-775-004-125	/	20
	225-325 mm	FBPY47	250K775-004-225	/	20
	325-425 mm	FBPY48	250K775-004-325	/	20
	425-525 mm	FBPY49	250K775-004-425	/	20
	525-625 mm	FBPY50	250K775-004-525	/	20
	625-725 mm	FBPY51	250K775-004-625	/	20
	725-825 mm	FBPY52	250K775-004-725	/	20
	825-925 mm	FBPY53	250K775-004-825	/	20
	925-1025 mm	FBPY54	250K775-004-925	/	20

1x
2x
3x
4x
5x
6x
7x
8x

FPBP10
Prolunga h 100 mm
inclusa nel prezzo
Extension h 100 mm
included in the price

ID	CODICE CODE	€ cad each	CONF PACK
FPBP10	250-700-603-006	/	20

Prolunga PBP10 (h 100 mm)
Extension PBP10 (h 100 mm)



BalancePro V0 RAIL

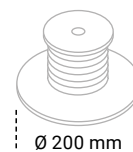

d 60 mm



d 40 mm

IMG.	H.min-max	ID	CODICE CODE	ID	CODICE CODE	€ cad each	CONF PACK
B	25-30 mm	FBPH01	250-735-001-025	FBPJ01	250-730-001-025	/	20
C	30-37 mm	FBPH02	250-735-001-030	FBPJ02	250-730-001-030	/	20
D	37-50 mm	FBPH03	250-735-001-037	FBPJ03	250-730-001-037	/	20
E	50-75 mm	FBPH04	250-735-001-050	FBPJ04	250-730-001-050	/	20
F	75-125 mm	FBPH05	250-735-001-075	FBPJ05	250-730-001-075	/	20
G	125-225 mm	FBPH06	250-735-001-125	FBPJ06	250-730-001-125	/	20
	225-325 mm	FBPH07	250K735-001-225	FBPJ07	250K730-001-225	/	20
	325-425 mm	FBPH08	250K735-001-325	FBPJ08	250K730-001-325	/	20
	425-525 mm	FBPH09	250K735-001-425	FBPJ09	250K730-001-425	/	20
	525-625 mm	FBPH10	250K735-001-525	FBPJ10	250K730-001-525	/	20
	625-725 mm	FBPH11	250K735-001-625	FBPJ11	250K730-001-625	/	20
	725-825 mm	FBPH12	250K735-001-725	FBPJ12	250K730-001-725	/	20
	825-925 mm	FBPH13	250K735-001-825	FBPJ13	250K730-001-825	/	20
	925-1025 mm	FBPH14	250K735-001-925	FBPJ14	250K730-001-925	/	20

1x

2x

3x

4x

5x

6x

7x

8x



FPBP10

Prolunga h 100 mm
inclusa nel prezzo
Extension h 100 mm
included in the price

+ **G**

BALANCEPRO KIT



TESTA AUTOLIVELLANTE
Con correzione automatica della pendenza fino al 5%

SELF-LEVELLING HEAD
with automatic slope correction up to 5%



TESTA FISSA
Con utilizzo dell'anello FIX RING

FIXED HEAD
with FIX RING

BLOCCO BASCULA
FIX RING
BB-BP

20 pz/pcs per conf/pack

Incluso nella scatola
Included in the box

BalancePro V0 DECKING

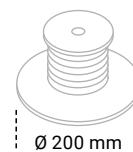

d 40-60 mm

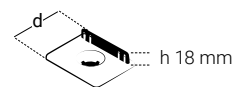

d max 70 mm

IMG.	H.min-max	ID	CODICE CODE	ID	CODICE CODE	€ cad each	CONF PACK
B	25-30mm	FBPX01	250-770-001-025	FBPD01	250-750-001-025	/	20
C	30-37 mm	FBPX02	250-770-001-030	FBPD02	250-750-001-030	/	20
D	37-50 mm	FBPX03	250-770-001-037	FBPD03	250-750-001-037	/	20
E	50-75 mm	FBPX04	250-770-001-050	FBPD04	250-750-001-050	/	20
F	75-125 mm	FBPX05	250-770-001-075	FBPD05	250-750-001-075	/	20
G	125-225 mm	FBPX06	250-770-001-125	FBPD06	250-750-001-125	/	20
	225-325 mm	FBPX07	250K770-001-225	FBPD07	250K750-001-225	/	20
	325-425 mm	FBPX08	250K770-001-325	FBPD08	250K750-001-325	/	20
	425-525 mm	FBPX09	250K770-001-425	FBPD09	250K750-001-425	/	20
	525-625 mm	FBPX10	250K770-001-525	FBPD10	250K750-001-525	/	20
	625-725 mm	FBPX11	250K770-001-625	FBPD11	250K750-001-625	/	20
	725-825 mm	FBPX12	250K770-001-725	FBPD12	250K750-001-725	/	20
	825-925 mm	FBPX13	250K770-001-825	FBPD13	250K750-001-825	/	20
	925-1025 mm	FBPX14	250K770-001-925	FBPD14	250K750-001-925	/	20

1x

2x

3x

4x

5x

6x

7x

8x



FPBP10

Prolunga h 100 mm
inclusa nel prezzo
Extension h 100 mm
included in the price

+ G



Prolunga PBP10 (h 100 mm)
Extension PBP10 (h 100 mm)

ID	CODICE CODE	€ cad each	CONF PACK
FPBP10	250-700-603-006	/	20



SteelMart TILE

FISSO | FIX

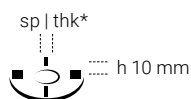

Testa Tile sp 2 mm
Tile head thk 2 mm

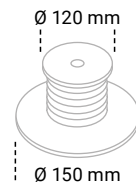

IMG.	H.min-max	ID	CODICE CODE	€ cad each	CONF PACK
B	25-32 mm	FP201	260-100-002-025	/	10
C	32-39 mm	FP202	260-100-002-032	/	10
D	39-46 mm	FP203	260-100-002-039	/	10
E	46-53 mm	FP204	260-100-002-046	/	10
F	53-70 mm	FP205	260-100-002-053	/	10
G	70-100 mm	FP206	260-100-002-070	/	10
H	100-140 mm	FP207	260-100-002-100	/	10
I	140-220 mm	FP208	260-100-002-140	/	10
L	220-300 mm	FP209	260-100-002-220	/	10

SteelMart DECKING

FISSO | FIX



Testa Decking d 60 mm
Decking head d 60 mm

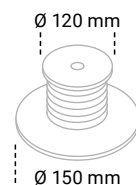

IMG.	H.min-max	ID	CODICE CODE	€ cad each	CONF PACK
B	25-32 mm	FPD01	260-105-000-025	/	10
C	32-39 mm	FPD02	260-105-000-032	/	10
D	39-46 mm	FPD03	260-105-000-039	/	10
E	46-53 mm	FPD04	260-105-000-046	/	10
F	53-70 mm	FPD05	260-105-000-053	/	10
G	70-100 mm	FPD06	260-105-000-070	/	10
H	100-140 mm	FPD07	260-105-000-100	/	10
I	140-220 mm	FPD08	260-105-000-140	/	10
L	220-300 mm	FPD09	260-105-000-220	/	10

A1 CLASS



ACCESSORI EXTRA EXTRA ACCESSORIES

Magatello alluminio Easy Rail 60x20x2 mm (barre da 2ml)
Aluminum joist Easy Rail 60x20x2 mm (2ml bars)



ID	CODICE CODE	€/ml	CONF PACK
MAR60	420-705-020-060	16,00	10 ML

Testa Top Rail
Top Rail Head



ID	CODICE CODE	sp thk (mm)	€ cad each	CONF PACK
FR200	260-010-000-002	2	/	10
FR400	260-010-000-004	4	/	10

Condizioni generali di vendita

Italia

DISCIPLINA DI VENDITA - IMPERTEK procede alla vendita dei propri prodotti secondo le norme che disciplinano la compravendita dei beni mobili contenute nel Codice Civile ed integrate con quelle specifiche delle leggi speciali e comunitarie. In ogni caso la parte acquirente, anche se di nazionalità diversa da quella Italiana, dichiara di accettare che il rapporto di compravendita sia disciplinato dalla legge Italiana.

PRODOTTI - I prodotti forniti sono conformi alle specifiche tecniche indicate da Impertek srl nelle relative schede tecniche dei prodotti e/o manuali di istruzione. Impertek srl si riserva la facoltà di modificare parametri tecnici e dimensionali in qualsiasi momento. Tutti i contenuti presenti in cataloghi prodotti, listini prezzi, sito web, possono essere modificati in qualsiasi momento e senza preavviso a discrezione di Impertek srl. Tutte le caratteristiche e i dati tecnici dei prodotti IMPERTEK hanno carattere informativo, quindi non impegnativo. La IMPERTEK si riserva la facoltà di apportare modifiche ai prodotti ed al loro confezionamento senza obbligo di preavviso.

PREZZI - Saranno applicati i prezzi in vigore all'atto della spedizione dei materiali. I prezzi si intendono IVA esclusa.

CONDIZIONI DI RESA

- CPT INCOTERMS® 2020 ICC (franco arrivo): costo del trasporto STANDARD incluso per ordini a partire da 750,00 € di imponibile, in caso contrario addebito spese di trasporto in fattura (vedi tabella sotto) con esclusione di Venezia ed isole minori per le quali verrà effettuata una quotazione ad hoc anche al raggiungimento del minimo imponibile.
- Eventuali richieste di spedizioni ESPRESSE (tassative) saranno sempre addebitate al costo.
- Imballo compreso se standard, al costo se speciale.

Gli ordini con quantità non conformi alle confezioni standard indicate saranno automaticamente elevate al multiplo superiore senza obbligo di preavviso. La IMPERTEK si riserva la facoltà di evadere ordini parziali in base alla disponibilità della merce.

CONSEGNA - Il trasporto può essere effettuato con nostri mezzi o tramite vettori convenzionati. La merce anche se resa franco destino, per un miglior servizio alla clientela, viaggia sempre a rischio e pericolo dell'acquirente, salva la responsabilità del vettore ai sensi dell'ART. 1693 C.C. I tempi di consegna, quando specificati, hanno valore indicativo. I ritardi non imputabili a nostra volontà non pregiudicano in ogni caso la validità dell'ordine.

RICEVIMENTO - Al ricevimento della merce controllare la corrispondenza tra documento di trasporto, ordine e quanto ricevuto. Verificare l'integrità esterna dell'imballo (assenza di urti o deterioramenti visibili)

RESI - Non si accettano resi di materiale se non preventivamente concordati. Per ogni reso autorizzato saranno addebitati 30 € di costo fisso amministrativo oltre ai costi di trasporto. I resi saranno accettati solo se le confezioni sono integre e sigillate: eventuali costi di nuovi imballi saranno addebitati al costo.

CONTESTAZIONI - Non si accettano reclami sulla qualità del prodotto sollevati dopo otto giorni dalla data di consegna.

PAGAMENTI - Da concordare. Ogni ritardo di pagamento darà diritto ad IMPERTEK di sospendere, senza avviso, qualsiasi altro ordine in corso e di addebitare al committente gli interessi bancari correnti. Tutti i pagamenti dovranno essere effettuati ai sensi dell'ART. 1182, 3° co. C.C. presso la nostra sede di Ceggia (Venezia). La merce rimane di proprietà di IMPERTEK fino al completo pagamento.

GARANZIA - I nostri prodotti sono coperti da polizza R.C. prodotti. IMPERTEK si impegna a riparare o sostituire i prodotti che presentino dei difetti tecnici di costruzione entro 12 mesi dalla consegna, purché la contestazione sia pervenuta ad IMPERTEK nei termini di legge.

FORO COMPETENTE - Per ogni controversia il foro competente sarà il Tribunale di Venezia. Per qualsiasi controversia relativa alla vendita tra IMPERTEK e la parte acquirente di nazionalità diversa da quella Italiana si applicano i criteri di cui all'art. 3 L. 31/05/1995 n. 218. Qualora tali criteri non sussistano, la parte acquirente di nazionalità diversa da quella Italiana, dichiara di accettare la giurisdizione Italiana dell'art. 4 1c. L. 31/05/1995 n. 218.

IMBALLI - Le confezioni indicate sono in vigore al momento della stampa del Listino. Eventuali modifiche di imballaggio dei Prodotti saranno a discrezione di Impertek srl a seconda delle esigenze.

POSA E UTILIZZO - Prima della posa del pavimento sopraelevato, verificare attentamente la corretta esecuzione delle specifiche tecniche indicate dai produttori dei sistemi impermeabili e isolanti; il piano di appoggio deve garantire un'adeguata portanza e stabilità a tutta la pavimentazione. Per i motivi sopra citati, Impertek srl declina ogni responsabilità in caso di movimento, cedimento e/o danneggiamento del piano di appoggio. In nessuna circostanza Impertek srl sarà responsabile di danni diretti o indiretti che possano derivare dall'uso improprio di qualsiasi prodotto e/o da eventuali modifiche sui prodotti che possono essere applicate senza alcun preavviso.

Il listino annulla e sostituisce i precedenti.

ADDEBITO SPESE DI TRASPORTO STANDARD IN FATTURA PER ORDINI INFERIORI A € 750,00 EURO * DI IMPONIBILE.

**SPONDA IDRAULICA ed eventuali trasporti ESPRESSE saranno calcolati al costo e addebitati in fattura anche per importi superiori ai 750,00 € di imponibile.
Per Venezia e le isole minori addebito del trasporto al costo anche per imponibile superiore a 750,00 €.**

Valle D'Aosta - Piemonte - Lombardia - Veneto	35,00 €
Trentino Alto Adige - Friuli Venezia Giulia - Emilia Romagna	
Toscana - Umbria - Marche - Abruzzo - Molise - Lazio - Liguria	39,00 €
Campania - Puglia - Basilicata - Calabria	42,00 €
Sicilia - Sardegna	50,00 €

* I costi di trasporto espressi ed eventuale sponda idraulica saranno comunicati con la conferma dell'ordine.

General sales conditions

Italy

SALES PROCEDURE · IMPERTEK sells its products in accordance with the rules governing the sale of moveable goods contained in the Civil Code and integrated with those specific to special and community laws. In any case the purchasing party, even if of a nationality other than Italian, declares its acceptance that the agreement of sale is governed by Italian law.

PRODUCTS · The products supplied comply with the technical specifications indicated by Impertek srl in the relevant product data sheets and/or instruction manuals. Impertek srl reserves the right to modify technical and dimensional parameters at any time. All contents present in product catalogues, price lists, website, can be modified at any time and without notice at the discretion of Impertek srl. All characteristics, photos and technical data of IMPERTEK products are of informative character and thus are not binding. IMPERTEK reserves the right to make modifications to its products and their packages without prior warning.

PRICES · Prices applied will be those in effect at the time of despatch of materials. Prices are VAT excluded.

TERMS OF DELIVERY IN ITALY

- CPT INCOTERMS® 2020 ICC (Italy): cost of STANDARD transport included for orders starting from € 750.00 taxable, otherwise transport costs will be charged on the invoice (see table below) with the exclusion of Venice and smaller islands for which an ad hoc quotation will also be made upon reaching the minimum taxable amount.
- Any requests for EXPRESS shipments (mandatory) will always be charged at cost.
- Packages included if standard, at cost if special.

Orders with quantities that do not comply with the standard packages indicated will be automatically raised to the higher multiple without prior notice. IMPERTEK reserves the right to fulfill partial orders based on the availability of the goods.

DELIVERY · The transport can be carried out with Impertek means of transportation or through affiliated carriers. The goods, even if delivered carriage paid, always travel at the buyer's risk, without prejudice to the carrier's liability pursuant to ART. 1693 C.C. Delivery times, when specified, are indicative. Delays not attributable to our will in any case do not affect the validity of the order.

RECEIPT · Upon receipt of the goods, always check the correspondence between transport document, order and how much received. Check the external integrity of the packaging (no visible impact or deterioration).

RETURNS · Returns of material are not accepted unless previously agreed. For each authorized return, a fixed administrative cost of € 30 will be charged in addition to transport costs. Returns will be accepted only if the packages are intact and sealed: any costs of new packages will be charged at cost.

COMPLAINTS · Complaints regarding the quality of products are not accepted after eight days from date of delivery.

PAYMENTS · To be agreed. Any delay in payment will give IMPERTEK the right to suspend, without warning, any other order in course and to debit the purchaser at the current bank interest rate. All payments should be made in accordance with ART. 1182, 3° Co, C.C. The goods remain the property of IMPERTEK until payment has been made.

GUARANTEE · IMPERTEK undertakes to repair or substitute products which present technical construction defects within twelve months from the date of delivery, on condition that the notification has been sent to IMPERTEK s.r.l respecting the above mentioned terms.

PLACE OF JURISDICTION · The competent law court is the law court of Venice. For any controversy related to the sale between IMPERTEK and the purchasing party of nationality other than Italian, criteria will be applied in accordance with art. 3 L. 31/05/1995 n.218. Should such criteria not exist, the purchasing party of nationality other than Italian, declares its acceptance of Italian jurisdiction art. 41c.L.31/05/1995 n. 218.

PACKAGING · The packages indicated are in force at the time of printing of the Price List. Any changes to the packaging of the Products will be at the discretion of Impertek srl, depending on the needs.

INSTALLATION AND USE · Before laying the raised floor, carefully check that the technical specifications indicated by the manufacturers of the waterproof and insulating systems have been carried out correctly; the support surface must guarantee an adequate lift and stability to the entire floor. For the reasons mentioned above, Impertek srl declines all responsibility in the event of movement, failure and/or damage to the support surface. Under no circumstances will Impertek srl be held liable for direct or indirect damages that may result from the improper use of any product and/or from any changes to the products that may be applied without any notice.

This price-list cancels and replaces the previous ones.

CHARGE OF STANDARD TRANSPORT COSTS FOR TAXABLE AMOUNTS NOT EXCEEDING € 750.00 EURO *.

HYDRAULIC LIFT and any EXPRESS transports will be calculated at cost and charged on the invoice even for amounts exceeding € 750.00 of taxable amount.

For Venice and the smaller islands, transport cost will be charged at cost even for taxable amounts exceeding € 750.00.

Valle D'Aosta - Piemonte - Lombardia - Veneto	35,00 €
Trentino Alto Adige - Friuli Venezia Giulia - Emilia Romagna	
Toscana - Umbria - Marche - Abruzzo - Molise - Lazio - Liguria	39,00 €
Campania - Puglia - Basilicata - Calabria	42,00 €
Sicilia - Sardegna	50,00 €

* The express transport costs and any tail lift will be communicated with the order confirmation.

Condizioni generali di vendita

Estero

DISCIPLINA DI VENDITA · IMPERTEK procede alla vendita dei propri prodotti secondo le norme che disciplinano la compravendita dei beni mobili contenute nel Codice Civile ed integrate con quelle specifiche delle leggi speciali e comunitarie. In ogni caso la parte acquirente, anche se di nazionalità diversa da quella Italiana, dichiara di accettare che il rapporto di compravendita sia disciplinato dalla legge Italiana.

PRODOTTI · I prodotti forniti sono conformi alle specifiche tecniche indicate da Impertek srl nelle relative schede tecniche dei prodotti e/o manuali di istruzione. Impertek srl si riserva la facoltà di modificare parametri tecnici e dimensionali in qualsiasi momento. Tutti i contenuti presenti in cataloghi prodotti, listini prezzi, sito web, possono essere modificati in qualsiasi momento e senza preavviso a discrezione di Impertek srl. Tutte le caratteristiche e i dati tecnici dei prodotti IMPERTEK hanno carattere informativo, quindi non impegnativo. La IMPERTEK si riserva la facoltà di apportare modifiche ai prodotti ed al loro confezionamento senza obbligo di preavviso.

PREZZI · Saranno applicati i prezzi in vigore all'atto della spedizione dei materiali. I prezzi si intendono IVA esclusa.

SPESE DI TRASPORTO · I prezzi sono da considerarsi EX-WORKS INCOTERMS® 2020 ICC franco fabbrica a Ceggia (Venezia). Su richiesta, possiamo organizzare la consegna diretta all'estero addebitando le spese in base al peso e al volume.

RICEVIMENTO · Al ricevimento della merce controllare la corrispondenza tra documento di trasporto, ordine e quanto ricevuto. Verificare l'integrità esterna dell'imballo (assenza di urti o deterioramenti visibili)

RESI · Non si accettano resi di materiale se non preventivamente concordati. Per ogni reso autorizzato saranno addebitati 30 € di costo fisso amministrativo oltre ai costi di trasporto. I resi saranno accettati solo se le confezioni sono integre e sigillate: eventuali costi di nuovi imballi saranno addebitati al costo.

CONTESTAZIONI · Non si accettano reclami sulla qualità del prodotto sollevati dopo otto giorni dalla data di consegna.

PAGAMENTI · Da concordare. Ogni ritardo di pagamento darà diritto ad IMPERTEK di sospendere, senza avviso, qualsiasi altro ordine in corso e di addebitare al committente gli interessi bancari correnti. Tutti i pagamenti dovranno essere effettuati ai sensi dell'ART. 1182, 3° co. C.C. presso la nostra sede di Ceggia (Venezia). La merce rimane di proprietà di IMPERTEK fino al completo pagamento.

GARANZIA · I nostri prodotti sono coperti da polizza R.C. prodotti. IMPERTEK si impegna a riparare o sostituire i prodotti che presentino dei difetti tecnici di costruzione entro 12 mesi dalla consegna, purché la contestazione sia pervenuta ad IMPERTEK nei termini di legge.

FORO COMPETENTE · Per ogni controversia il foro competente sarà il Tribunale di Venezia. Per qualsiasi controversia relativa alla vendita tra IMPERTEK e la parte acquirente di nazionalità diversa da quella Italiana si applicano i criteri di cui all'art. 3 L. 31/05/1995 n. 218. Qualora tali criteri non sussistano, la parte acquirente di nazionalità diversa da quella Italiana, dichiara di accettare la giurisdizione Italiana dell'art. 4 1c. L. 31/05/1995 n. 218.

IMBALLI · Le confezioni indicate sono in vigore al momento della stampa del Listino. Eventuali modifiche di imballaggio dei Prodotti saranno a discrezione di Impertek srl a seconda delle esigenze.

POSA E UTILIZZO · Prima della posa del pavimento sopraelevato, verificare attentamente la corretta esecuzione delle specifiche tecniche indicate dai produttori dei sistemi impermeabili e isolanti; il piano di appoggio deve garantire un'adeguata portanza e stabilità a tutta la pavimentazione. Per i motivi sopra citati, Impertek srl declina ogni responsabilità in caso di movimento, cedimento e/o danneggiamento del piano di appoggio. In nessuna circostanza Impertek srl sarà responsabile di danni diretti o indiretti che possano derivare dall'uso improprio di qualsiasi prodotto e/o da eventuali modifiche sui prodotti che possono essere applicate senza alcun preavviso.

Il presente listino annulla e sostituisce i precedenti.

General sales conditions

Abroad

SALES PROCEDURE · IMPERTEK sells its products in accordance with the norms governing the sale of moveable goods contained in the Civil Code and integrated with those specific to special and community laws.

In any case the purchasing party, even if of a nationality other than Italian, declares its acceptance that the agreement of sale is governed by Italian law.

PRODUCTS · The products supplied comply with the technical specifications indicated by Impertek srl in the relevant product data sheets and/or instruction manuals. Impertek srl reserves the right to modify technical and dimensional parameters at any time. All contents present in product catalogues, price lists, website, can be modified at any time and without notice at the discretion of Impertek srl. All characteristics, photos and technical data of IMPERTEK products are of informative character and thus are not binding. IMPERTEK reserves the right to effect modifications to its products and their packages without prior warning.

PRICES · Prices applied will be those in effect at the time of despatch of materials.

TRANSPORT CHARGES · Prices are always EX-WORKS INCOTERMS® 2020 ICC at our Factory in Ceggia (Venice)
On request, we could arrange deliveries door to door debiting their charges according to weight and volume.

RECEIPT · Upon receipt of the goods, always check the correspondence between transport document, order and how much received. Check the external integrity of the packaging (no visible impact or deterioration).

RETURNS · Return of materials is not accepted unless previously agreed. For every accepted returns 30 € will be charged as fixed administrative cost. Returned goods are accepted only if the packages is whole and sealed. In any case the charge for return of material will be borne by the client who will also be charged for eventual packages no longer usable.

COMPLAINTS · Complaints regarding the quality of products are not accepted after eight days from date of delivery.

PAYMENTS · To be agreed. Any delay in payment will give IMPERTEK the right to suspend, without warning, any other order in course and to debit the purchaser at the current bank interest rate.

All payments should be effected in accordance with ART. 1182, 3° Co, C.C. at our head office in Ceggia (Venice).

The goods remain the property of IMPERTEK until payment has been completed.

GUARANTEE · IMPERTEK undertakes to repair or substitute products which present technical construction defects within twelve months from the date of delivery, on condition that the notification has been sent to IMPERTEK s.r.l respecting the above mentioned terms.

PLACE OF JURISDICTION · The competent law court is the law court of Venice. For any controversy related to the sale between IMPERTEK and the purchasing party of nationality other than Italian, criteria will be applied in accordance with art. 3 L. 31/05/1995 n.218. Should such criteria not exist, the purchasing party of nationality other than Italian, declares its acceptance of Italian jurisdiction art. 41c.L.31/05/1995 n. 218.

PACKAGING · The packages indicated are in force at the time of printing of the Price List. Any changes to the packaging of the Products will be at the discretion of Impertek srl, depending on the needs.

INSTALLATION AND USE · Before laying the raised floor, carefully check that the technical specifications indicated by the manufacturers of the waterproof and insulating systems have been carried out correctly; the support surface must guarantee an adequate lift and stability to the entire floor. For the reasons mentioned above, Impertek srl declines all responsibility in the event of movement, failure and/or damage to the support surface. Under no circumstances will Impertek srl be held liable for direct or indirect damages that may result from the improper use of any product and/or from any changes to the products that may be applied without any notice.

This price-list cancels and replaces the previous ones.

IMPERTEK Srl

via Po 507 · 30022 · Ceggia · Venezia · Italy
T +39 0421 322 525 r.a · F +39 0421 322 756
info@impertek.com · www.impertek.com

Pedestal Line

Listino prezzi | Pricelist
Validità dal 1 marzo 2026 | Valid from 1st of March 2026

Release

2026_Rev00

Art direction

Visualcom s.r.l.u.

Images and communication design:

Visualcom s.r.l.u.

Tutti i diritti sono riservati. Nessuna parte di questa brochure può essere riprodotta in qualunque forma senza autorizzazione di Impertek s.r.l. | All right reserved. No part of this publication may be reproduced in any form without prior permission from Impertek s.r.l.



impertek.com

Visita il nostro sito e registrati per accedere a più contenuti!
Visit our website and sign up to access more content!



Via Po 507, Ceggia (VE) Italy
Tel. +39 0421 322525 r.a. - Fax +39 0421 322756
info@impertek.com - www.impertek.com