

SAMOREZNI ŠRAFOVI

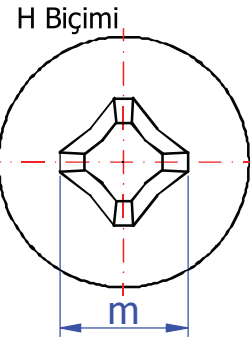
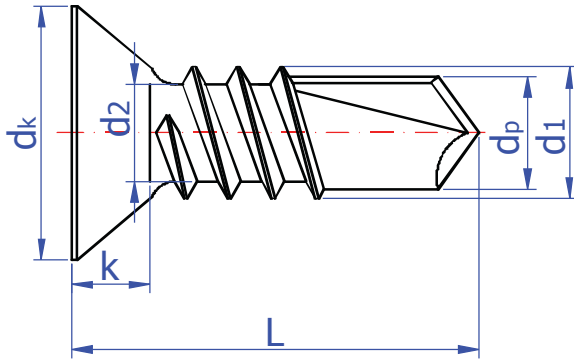

Anma Çapı	Minimum burulma dayanımı N.m
3.9	3.4
4.2	4.7
4.8	6.9

	3.9	4.2	4.8
YHB	-0.15	-0.15	-0.15
YSB	+0.35	+0.25	+0.10

Anma Çapı	3.9	4.2	4.8	L	min.	max.		
P (Adım)	1.4	1.4	1.6	13	12.1	13.9		
d1	max.	3.91	4.22	4.8	16	15.1	16.9	
	min.	3.73	4.04	4.62	19	18	20	
d2	max.	2.92	3.1	3.58	22	21	23	
	min.	2.77	2.95	3.43	25	24	26	
k ~	-	2.6	2.8	32	30.75	33.25		
dk	max.	7.50	8.40	9.30	38	36.75	39.25	
	min.	7.14	8.00	8.90	45	43.75	46.25	
dp max.	3.1	3.6	4.1	50	48.75	51.25		
m Form H		4.40	4.60	5.20	60	58.75	61.25	
	Yıldız Derinliği	min.	2.03	2.10	2.70	70	68.75	71.25
	max.	2.53	2.60	3.20	80	78.75	81.25	

ZA OKIVANJE PVC STOLARIJE

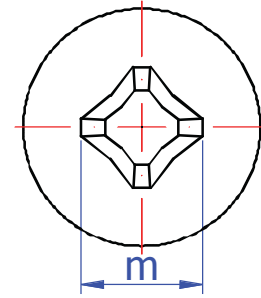
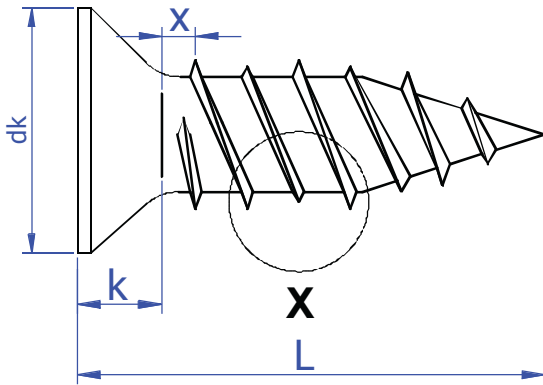

Anma Çapı	Minimum burulma dayanımı N.m
3.9	3.4
4.2	4.5

	3.9	4.2
YHB	-0.15	-0.15
YSB	+0.35	+0.25

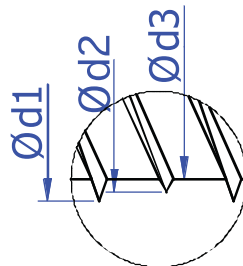

DETAY X

Anma Çapı	3.9	4.2	L	min.	max.		
d1	max.	3.90	4.25				
	min.	3.75	4.15				
d2	max.	3.10	3.15				
	min.	3.00	3.10				
d3	max.	2.55	2.80				
	min.	2.50	2.70				
k ~	2.60	3.00	19	18.10	19		
dk	max.	7.30	7.60	22	21.10	22	
	min.	7.10	7.40	25	24.10	25	
m Form H		4.60	4.60	32	31.00	32	
	Yıldız Derinliği	min.	2.03	2.03	38	37.00	38
	max.	2.53	2.53	45	44.00	45	

TURBO VIJCI

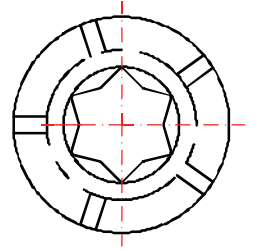
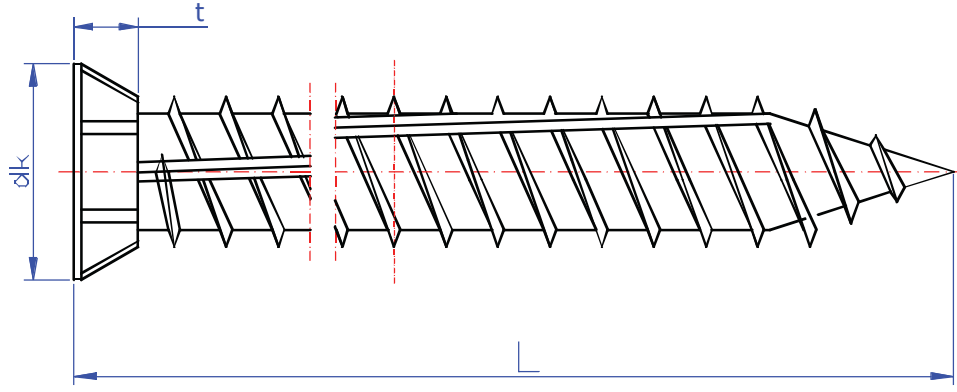

T30 YILDIZ

Anma Çapı	60	80	100	120	150	180	200
$\varnothing d_1$	max.	7.50	7.50	7.50	7.50	7.50	7.50
	min.	7.20	7.20	7.20	7.20	7.20	7.20
$\varnothing d_2$	max.	5.20	5.10	5.10	5.10	5.10	5.10
	min.	5.00	4.90	4.90	4.90	4.90	4.90
dk	max.	11.00	11.00	11.00	11.00	11.00	11.00
	min.	10.60	10.60	10.60	10.60	10.60	10.60
t	max.	3.96	3.96	3.96	3.96	3.96	3.96
	min.	3.60	3.60	3.60	3.60	3.60	3.60

L	min.	max.
60	58.5	60
80	78.0	80
100	98.0	100
120	118.0	120
150	147.5	150
180	177.0	180
200	197.0	200

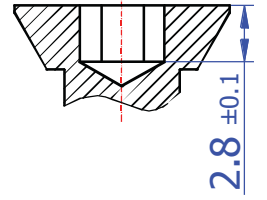
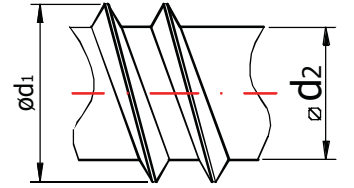

2.8 ±0.1